



NATIONAL AERONAUTICS AND SPACE ADMINISTRATION

APOLLO LUNAR SURFACE EXPERIMENTS PACKAGE SYSTEMS HANDBOOK

APOLLO 16

ALSEP 3
ARRAY D

JANUARY 12, 1972

PREPARED BY
FLIGHT CONTROL DIVISION

MANNED SPACECRAFT CENTER
HOUSTON, TEXAS

1 INTRODUCTORY
INFORMATION

2 GENERAL
DESCRIPTION

3 STRUCTURAL/
THERMAL CNTL
SUBSYSTEM

4 ELECTRICAL
POWER
SUBSYSTEM

5 COMMAND
SUBSYSTEM

6 TELEMETRY
SUBSYSTEM

7 PSE (S031)

8 LSM EXP (S034)

9 ASE (S033)

10 HFE (S037)

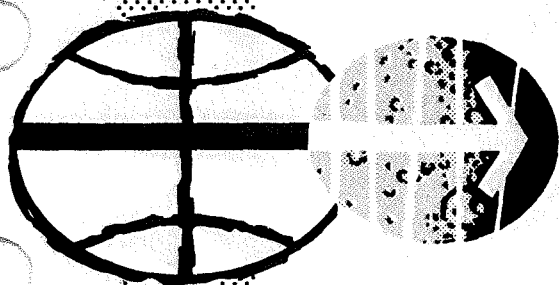

*

APOLLO LUNAR SURFACE EXPERIMENTS PACKAGE SYSTEMS HANDBOOK

APOLLO 16

ALSEP 3

PREFACE

This document has been prepared by the Flight Control Division, Manned Spacecraft Center, Houston, Texas, with technical assistance by Service Technology Corporation (STC). Information contained within this document represents the Apollo Lunar Surface Experiments Package (ALSEP) systems for ALSEP 3 (ARRAY D) as of January 12, 1972.

This document is intended for specialized use by experiment flight controllers in real-time and near-real-time operations.

Comments regarding this handbook should be directed to the Lunar/Earth Experiments Branch, Flight Control Division. Revisions will be issued as required prior to the flight date.

This document is not to be reproduced without the written approval of the Chief, Flight Control Division, Manned Spacecraft Center, Houston, Texas.

Approved by:

Gerald D. Griffith
for James E. Saultz
Chief, Lunar/Earth Experiments Branch

Melvin F. Brooks
for Eugene F. Kranz
Chief, Flight Control Division

APOLLO LUNAR SURFACE EXPERIMENTS PACKAGE SYSTEMS HANDBOOK

ALSEP 3

BASIC

JANUARY 12, 1972

TABLE OF CONTENTS AND ITEM EFFECTIVITY

ITEM	TITLE	REV	PCN	SIGNOFF/ DATE	PAGE	REMARKS
<u>SECTION 1 INTRODUCTORY INFORMATION</u>						
PAR 1.1	ABBREVIATIONS AND ACRONYMS	BASIC		1/12/72	1-1	
PAR 1.2	DRAWING SYMBOL STANDARDS	BASIC		1/12/72	1-7	
<u>SECTION 2 GENERAL DESCRIPTION</u>						
PAR 2.1	ALSEP DESCRIPTION	BASIC		1/12/72	2-1	
FIG 2-1	ALSEP 3 (ARRAY "D")	BASIC		1/12/72	2-2	
FIG 2-2	ALSEP SUBPACKAGE 1	BASIC		1/12/72	2-3	
FIG 2-3	ALSEP SUBPACKAGE 2	BASIC		1/12/72	2-4	
FIG 2-4	MORTAR PACKAGE PALLET	BASIC		1/12/72	2-5	
<u>SECTION 3 STRUCTURAL/THERMAL CONTROL SUBSYSTEM</u>						
DWG 3.1	SUNSHIELD	BASIC		1/12/72	3-1	
DWG 3.2	THERMAL PLATE	BASIC		1/12/72	3-2	
DWG 3.3	PRIMARY STRUCTURE	BASIC		1/12/72	3-3	
DWG 3.4	THERMAL BAG	BASIC		1/12/72	3-4	
DWG 3.5	CENTRAL STATION SENSORS, HEATERS, AND SWITCHES	BASIC		1/12/72	3-5	
<u>SECTION 4 ELECTRICAL POWER SUBSYSTEM</u>						
PAR 4.1	SYSTEM DESCRIPTION	BASIC		1/12/72	4-1	
DWG 4.1	RTG TEMP SENSOR LOCATIONS	BASIC		1/12/72	4-2	
FIG 4-1	RTG WARMUP CHARACTERISTICS	BASIC		1/12/72	4-3	
FIG 4-2	RTG HOT AND COLD FRAME TEMPS VS RTG CURRENT (TYPICAL)	BASIC		1/12/72	4-5	
TAB 4-I	PCU OVER AND UNDER VOLTAGE	BASIC		1/12/72	4-11	
TAB 4-II	POWER CALCULATIONS	BASIC		1/12/72	4-11	
TAB 4-III	PDU RELAY INITIAL CONDITIONS	BASIC		1/12/72	4-12	
FIG 4-3	POWER DISSIPATION DISTRIBUTION	BASIC		1/12/72	4-13	
FIG 4-4	PCU LOAD VS RTG POWER OUTPUT VS CENTRAL STATION DISSIPATION	BASIC		1/12/72	4-14	
FIG 4-5	INTERNAL REGULATOR DISSIPATION	BASIC		1/12/72	4-15	
TAB 4-IV	CIRCUIT BREAKER AND FUSE TABULATION	BASIC		1/12/72	4-16	
TAB 4-V	VOLTAGE DISTRIBUTION AND BUS LOAD ANALYSIS	BASIC		1/12/72	4-17	
TAB 4-VI	COMMANDS CAUSING DELTA POWER DEMANDS	BASIC		1/12/72	4-18	
TAB 4-VII	CENTRAL STATION STEADY STATE POWER DEMANDS ON EACH VOLTAGE BUS FROM THE PCU	BASIC		1/12/72	4-20	
TAB 4-VIII	RELAY DRIVER FUNCTIONS AND INPUT VOLTAGE REQUIREMENTS	BASIC		1/12/72	4-21	
FIG 4-6	RELAY DRIVER VOLTAGES	BASIC		1/12/72	4-21	
DWG 4.2	POWER DISTRIBUTION AND FUNCTIONAL BLOCK DIAGRAM	BASIC		1/12/72	4-22	

TABLE OF CONTENTS AND ITEM EFFECTIVITY 1/12/72 - CONTINUED

ITEM	TITLE	REV	PCN	SIGNOFF/ DATE	PAGE	REMARKS
<u>SECTION 5 COMMAND SUBSYSTEM</u>						
PAR 5.1	COMMAND RECEIVER FUNCTIONAL DESCRIPTION	BASIC		1/12/72	5-1	
PAR 5.2	COMMAND FUNCTIONS	BASIC		1/12/72	5-2	
DWG 5.1	COMMAND SUBSYSTEM	BASIC		1/12/72	5-25	
<u>SECTION 6 TELEMETRY SUBSYSTEM</u>						
PAR 6.1	SYSTEM DESCRIPTION	BASIC		1/12/72	6-1	
FIG 6-1	DATA PROCESSOR FLOW DIAGRAM	BASIC		1/12/72	6-6	
TAB 6-I	ANALOG MULTIPLEXER, A/D CONVERTER CHARACTERISTICS	BASIC		1/12/72	6-7	
TAB 6-II	DIGITAL DATA PROCESSOR CHARACTERISTICS	BASIC		1/12/72	6-7	
TAB 6-III	TIMING FROM DIGITAL PROCESSOR	BASIC		1/12/72	6-8	
TAB 6-IV	TIMING AND CONTROL PULSE CHARACTERISTICS	BASIC		1/12/72	6-8	
FIG 6-2	ALSEP WORD ASSIGNMENT FOR ARRAY D	BASIC		1/12/72	6-9	
FIG 6-3	CONTROL AND COMMAND VERIFICATION WORD FORMAT	BASIC		1/12/72	6-10	
TAB 6-V	TELEMETRY SUBSYSTEM POWER REQUIREMENTS AND OVERLOAD PROTECTION	BASIC		1/12/72	6-11	
TAB 6-VI	TRANSMITTER CHARACTERISTICS	BASIC		1/12/72	6-11	
TAB 6-VII	CHANNEL AND MEASUREMENT ASSIGNMENTS FOR ANALOG MULTIPLEXER (ALSEP WORD 33)	BASIC		1/12/72	6-12	
TAB 6-VIII	ANALOG CHANNEL USAGE	BASIC		1/12/72	6-13	
TAB 6-IX	PSE MEASUREMENTS	BASIC		1/12/72	6-15	
TAB 6-X	LSM MEASUREMENTS	BASIC		1/12/72	6-16	
TAB 6-XI	LSM 16 POINT ENGINEERING SUBCOMMUTATION FORMAT AND ENGINEERING STATUS BIT STRUCTURE LOCATED IN ALSEP MAIN FRAME, WORD 5	BASIC		1/12/72	6-17	
TAB 6-XII	ACTIVE SEISMIC EXPERIMENT MEASUREMENTS LIST, ALSEP 3 (ASE IN OPERATE SELECT, HBR ONLY)	BASIC		1/12/72	6-18	
TAB 6-XIII	ACTIVE SEISMIC EXPERIMENT MEASUREMENTS LIST, ALSEP 3	BASIC		1/12/72	6-19	
FIG 6-6	HFE WORD FORMAT	BASIC		1/12/72	6-20	
TAB 6-XIV	HFE MEASUREMENTS, MODE 1 AND 2 GRADIENT AND LOW CONDUCTIVITY	BASIC		1/12/72	6-21	
TAB 6-XV	HFE MEASUREMENTS, MODE 3, HIGH CONDUCTIVITY	BASIC		1/12/72	6-22	
TAB 6-XVI	HFE MEASUREMENTS, ANALOG	BASIC		1/12/72	6-22	
DWG 6.1	TELEMETRY SUBSYSTEM	BASIC		1/12/72	6-23	
DWG 6.2	MECHANICAL ANALOGY OF TELEMETRY COMMUTATIONS	BASIC		1/12/72	6-24	
DWG 6.3	CENTRAL STATION AND RTG INSTRUMENTATION DIAGRAM	BASIC		1/12/72	6-25	
<u>SECTION 7 PASSIVE SEISMIC EXPERIMENT (S031)</u>						
PAR 7.1	SYSTEM DESCRIPTION	BASIC		1/12/72	7-1	
TAB 7-I	PSE PRESET CONDITIONS	BASIC		1/12/72	7-3	
TAB 7-II	PSE LEVELING RATES	BASIC		1/12/72	7-3	
FIG 7-1	PSE POWER PROFILE	BASIC		1/12/72	7-4	
DWG 7.1	PSE SYSTEM SCHEMATIC	BASIC		1/12/72	7-5	

TABLE OF CONTENTS AND ITEM EFFECTIVITY 1/12/72 - CONCLUDED

ITEM	TITLE	REV	PCN	SIGNOFF/ DATE	PAGE	REMARKS
<u>SECTION 8 LUNAR SURFACE MAGNETOMETER EXPERIMENT (S034)</u>						
PAR 8.1	SYSTEM DESCRIPTION	BASIC		1/12/72	8-1	
PAR 8.2	FLIP-CALIBRATION SEQUENCE	BASIC		1/12/72	8-2	
DWG 8.1	LSM FLIP CALIBRATION SEQUENCE	BASIC		1/12/72	8-3	
PAR 8.3	SITE-SURVEY SEQUENCE	BASIC		1/12/72	8-5	
DWG 8.2	LSM X, Y, Z SITE SURVEY SEQUENCES	BASIC		1/12/72	8-6	
TAB 8-1	LSM PRESET CONDITIONS	BASIC		1/12/72	8-9	
FIG 8-1	LSM POWER PROFILE	BASIC		1/12/72	8-10	
DWG 8.3	LSM SYSTEM SCHEMATIC	BASIC		1/12/72	8-11	
<u>SECTION 9 ACTIVE SEISMIC EXPERIMENT (S033)</u>						
PAR 9.1	SYSTEM DESCRIPTION	BASIC		1/12/72	9-1	
PAR 9.2	FUNCTIONAL DESCRIPTION	BASIC		1/12/72	9-2	
FIG 9-1	ASE MAJOR COMPONENTS	BASIC		1/12/72	9-3	
TAB 9-1	ASE GRENADE CHARACTERISTICS	BASIC		1/12/72	9-7	
PAR 9.3	GRENADE OPERATION	BASIC		1/12/72	9-9	
PAR 9.4	SAFETY FEATURES	BASIC		1/12/72	9-11	
FIG 9-2	ASE THUMPER	BASIC		1/12/72	9-13	
FIG 9-3	ASE POWER PROFILE	BASIC		1/12/72	9-15	
DWG 9.1	ASE SYSTEMS SCHEMATICS	BASIC		1/12/72	9-16	
<u>SECTION 10 HEAT FLOW EXPERIMENT (S037)</u>						
PAR 10.1	SYSTEM DESCRIPTION	BASIC		1/12/72	10-1	
FIG 10-1	HFE POWER PROFILE	BASIC		1/12/72	10-2	
PAR 10.2	HFE MODES	BASIC		1/12/72	10-4	
TAB 10-1	HFE MEASUREMENT OPTIONS (MODES 1 AND 2)	BASIC		1/12/72	10-6	
FIG 10-2	HEAT FLOW EXPERIMENT	BASIC		1/12/72	10-7	
FIG 10-3	HEAT FLOW BLOCK DIAGRAM	BASIC		1/12/72	10-8	
FIG 10-4	HEAT FLOW PROBE MEASUREMENT SEQUENCES	BASIC		1/12/72	10-9	
DWG 10.1	HFE SYSTEM SCHEMATIC	BASIC		1/12/72	10-10	

**1 INTRODUCTORY
INFORMATION**

SECTION 1
INTRODUCTORY INFORMATION

1.1 ABBREVIATIONS AND ACRONYMS

NOTE

Due to reduction requirements, acronyms which would normally be in lower case, for example, "dc," will appear in upper case on drawings. The text will, however, conform to NASA standards.

ac	alternating current
ACCP	accept
ACK	acknowledge
A/DC	analog-to-digital converter
Adc	amperes dc
ADD	address
AGC	automatic gain control
ALHT	Apollo lunar hand tools
ALIGN	alignment
ALSD	Apollo lunar surface drill
ALSEP	Apollo Lunar Surface Experiments Package
A/F	automatic/forced
AMPS	amperes
ANT	antenna
APP	approximate, approximately
ARM	armed
ASC	ascent
ASE	Active Seismic Experiment
ASI	Apollo standard initiator
AUTO	automatic
AZ	azimuth
BL	bottom location of structure temperature
BAS	base
BER	bit error rate
BFS	bits per second
C	centigrade
CAL	calibrate
CALC	calculated
CB	circuit breaker
CEL	cable
CCGE	Cold Cathode Gage Experiment (part of SIDE on ALSEP 1, 4, and A2, separate MSC experiment on ALSEP 3)
CCGE/A } CCGE/D }	analog and digital ID readout from CCGE
CCIG	Cold Cathode Ion Gage (instrument portion of CCGE)
CCW	counterclockwise
CH	channel
CH	change
CHAN	Channeltron; used in CPE as: CHAN/1 Channeltron P/S #1 CHAN/2 Channeltron P/S #2 CHAN/HI Channeltron Voltage Increase ON CHAN/LO Channeltron Voltage Increase OFF
CLD	cold
CMD	command
CNT	count

CNTS	counts
CNTR	counter
COMM	communications
CONV	converter
CPLER or CPE	Charged-Particle Experiment (full name is Charged-Particle Lunar Environment Experiment)
CPS	cycles per second
CS	central station
CTL	control
CUR	current
CVR	cover
CVR/S	cover and seal (used on SIDE)
CVW	command verification word
CW	clockwise
db	decibels
dbm	decibels with respect to one milliwatt
dc	direct current
DEC	decoder
DECR	decrease
DEF	deflection
DEG	degrees
DESC	descent
DET	detector
DIG	digital
DIR	direction
DIR/V	direction and speed (used on PSE)
DISSIP	dissipation
DLAY	delay
D/P	data processor
DPLY	deploy
DRT	dome removal tool
DSS	Data Subsystem
DSS/A	Analog Data Processor
DSS/D	Digital Data Processor
DSS/PROC	Complete Data Processor (Redundant)
DTREM	Dust, Thermal, and Radiation Engineering Measurements Package
EGFU	Electronics/Gimbal-Flip Unit
ENBL	enable
EPS	Electrical Power System
eV	electron volts
EXP	experiment
EXT	external
F	fuse
F	Fahrenheit
FET	field effect transistor
FILT	filter
FLD	field
FREQ	frequency
FTT	fuel transfer tool
FWD	forward

GDT	gradient sensor delta temperatures (HFE)
GEO	geophone
GLA	Grenade Launch Assembly (a component of ASE)
GMBL	gimbal
GND	ground
GT	gradient sensor ambient temperatures (HFE)
HBR	high bit rate
HE	high explosive (ASE grenades)
HECPA	High-Energy Curved-Plate Analyzer (a component of SIDE)
HFE	Heat Flow Experiment
HI	high
HTR	heater: On HFE there are two cases: . HTR/HK High Conductivity Heater HTR/LK Low Conductivity Heater
HS	heat sink
HV	high voltage
Hz	hertz
ID	identification
IN	input
INCR	increase
IND	indication
INHIB	inhibit
INIT	initiate
INST	instrument
INSUL	insulation
INT	internal
K	Kelvin
kbps	kilobits per second
kc	kilocycles
kHz	kilohertz
kV	kilovolts
LAT	latitude
LBR	low bit rate
LECPA	Low-Energy Curved-Plate Analyzer (a component of SIDE)
LIM	limit
LM	Lunar Module
LO	low
LONG	longitude
L/O	local oscillator
LOS	loss of signal
LP	long period (PSE sensors)
LSB	least significant bit
LSD	least significant data
LSM	Lunar Surface Magnetometer
LVL	level
mA	milliampere
mAdc	milliamperes dc
MAP	message acceptance pulse

MAX	maximum
Mc	megacycle
MCC	Mission Control Center
MDE	mode
MEAS	measurement
MeV	million electron volts
MHz	megahertz
MIN	minimum
MOCR	Mission Operations Control Room
MOD	module
MODE	operating modes are defined as follows: For HFE MODE/G gradient mode MODE/HK high conductivity mode MODE/LK low conductivity mode
ms	millisecond
MSB	most significant bit
MSD	most significant data
MSP	measurement sequence programmer
MSFN	Manned Space Flight Network
MTR	motor; on PSE, the three motors are MTRX, MTRY, and MTRZ
MUX	multiplexer or multiplex
mV	millivolts
mW/cm ²	milliwatts per square centimeter
nA	nanoamperes
N/A	not applicable
NBR	normal bit rate
NEG	negative
NORM	normal
NRZC	Non-Return to Zero Type C (Change)
OPER	operate
O/S	offset
OSC	oscillator
O/T	one-time
OUT	output
PA	power amplifier
pA	picoamperes
PCM	pulse code modulation
PCT	percent
PCU	Power Conditioning Unit
PDM	Power Dissipation Module
PDR	power dissipation resistor
PDU	Power Distribution Unit
PET	package elapsed time
PHYS	physical; on CPE used as follows: PHY/AN Physical Analyzer (sensor assembly)
PKG	package
PL	plane
PLT	plate
PM	phase modulation
POS	positive

POSN position
 PRE/LIM prelimiting
 PRE/REG preregulator (a component of the SIDE power supply)
 PRI primary; on ALSEP used as follows:
 PRI/ST primary structure
 P/S power supply
 PSE Passive Seismic Experiment; also:
 PSE/LP long-period sensors
 PSE/SP short-period sensors
 PSE/LP/SP long- and short-period sensors
 Long-period sensors are further defined as PSE/X, PSE/Y, and PSE/Z, while
 PSE/XY denotes the two horizontal long-period sensors
 PWR power

 R resistor (used as R1 and R2)
 RCVD received
 RCVR receiver
 RDT ring sensor delta temperature (HFE)
 REF reference
 REG regulator (also used as "register" on ALSEP)
 REV reverse
 RF radio frequency
 RLY relay
 R/S remote site
 RST reset
 RT rate (as in BIT RT, CNT RT, etc.)
 RT ring sensor ambient temperatures (HFE)
 RTC real-time command
 RTE real-time event
 RTG Radioisotope Thermoelectric Generator

 SCI scientific
 SEC second
 SEL select
 SEQ sequence, sequential; used on HFE as:
 SEQ/FUL Full Sequence
 SEQ/P1 Probe 1 Sequence
 SEQ/P2 Probe 2 Sequence
 Used on ASE as:
 SEQ/S Sequential Single
 SEQ scientific equipment
 SIDE Suprathermal Ion Detector Experiment; also:
 SIDE/A } analog and digital voltages
 SIDE/D } or readings
 SIDE/HE high-energy data
 SIDE/LE low-energy data
 SIDE/LHE least significant high-energy digital data
 SIDE/LLE least significant low-energy digital data
 SIDE/MHE most significant high-energy digital data
 SIDE/MLE most significant low-energy digital data
 SIG signal
 SLA Spacecraft Lunar Module Adapter
 SNSR sensor

SP short period (PSE sensor)
SFST single pole single throw
STA status
STBY standby
S/S samples per second, signal strength
S/T structural/thermal
SWS Solar Wind Spectrometer
SYNC synchronization
SW switch
SUP supply
SYS system

T temperature (also used as "thermal" on ALSEP)
TC thermocouple (on HFE, four cable ambient temperatures are read on each probe)
T/D time delay
TEMP temperature
THERM thermal
TM telemetry

UHT Universal Handling Tool
USB unified S-band

V volts, velocity (used to indicate "speed" on PSE in "LVL DIR/V")
Vac volts ac
Vdc volts dc
VCO voltage controlled oscillator
V/FILT Velocity Filter, a component of SIDE

W watts
W1, W2, W3 wall locations of structure temperature sensors

XMTR transmitter
XTAL crystal
XYZ } axes of LSM, where XYO indicates
XYO } X, or Y, or neither

φ phase

1.2 DRAWING SYMBOL STANDARDS

1.2.1 GENERAL DRAWING INFORMATION

A. ZONE REFERENCE

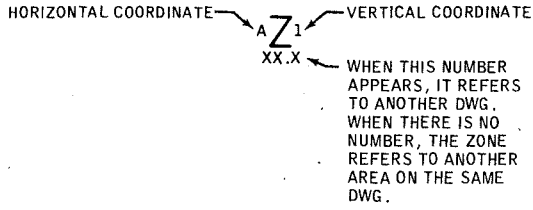

B. POWER INTRA-DRAWING ZONE REFERENCE

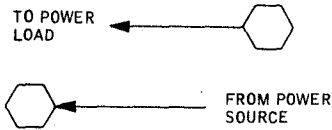

C. SYSTEM INTERCONNECT

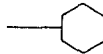

D. DRAWING NOTE REFERENCE



1.2.2 LINE LEGEND

A. RF CABLE

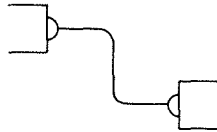

B. ELECTRICAL LINE, POWER AND CONTROL



1. ELECTRICAL, CONNECTED



2. ELECTRICAL, CROSSOVER

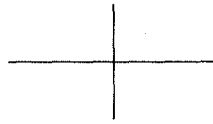

C. DIRECTIONAL FLOW ARROWS



D. COMPONENT ENCLOSURES (TYPICAL)

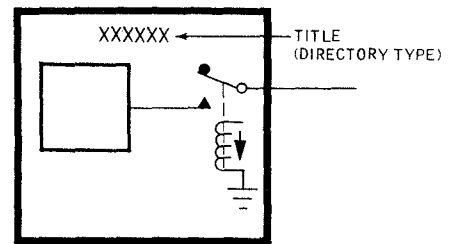

- 1. MAIN ENCLOSURE 1/16-INCH SOLID BLACK LINE
- 2. SUB ENCLOSURE 1/32-INCH SOLID BLACK LINE
- 3. COMPONENT ENCLOSURE WITH CREW (MANUAL CONTROL) 1/16-INCH DASHED BLACK LINE
- 4. EXPERIMENT INTERFACE 1/8-INCH DASHED BLACK LINE

EXPERIMENT **ALSEP**

E. MECHANICAL LINKAGE

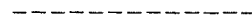

F. TIMING PULSES

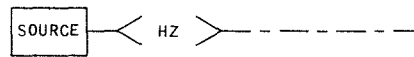

G. TWO-UNIT INTERFACE

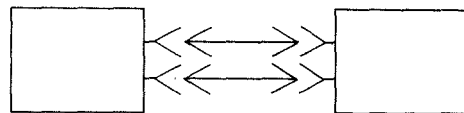

1.2.3 TELEMETRY SYMBOLS

A. MEASUREMENTS TELEMETERED

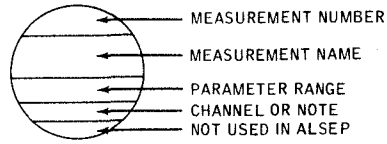

B. METERS



C. SINGLE SOURCE SENSOR

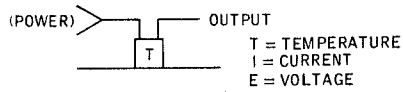

D. COMMANDS

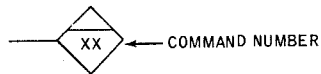

1.2.4 ELECTRICAL SYMBOLS

A. SWITCHES

1. MOMENTARY CONTACT

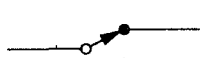

2. LATCHING CONTACT

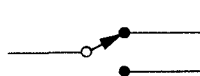

3. SOLID PUSHBUTTON

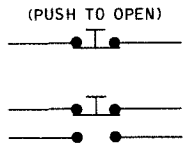

B. FUSES

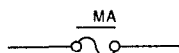

C. RELAYS

1. MOMENTARY CONTACTS

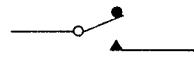

2. LATCHING CONTACTS

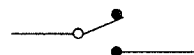

3. NON-LATCHING RELAY SHOWN IN DE-ENERGIZED POSITION

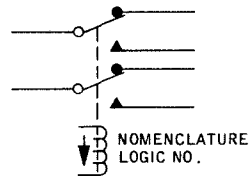

4. LATCHING RELAY

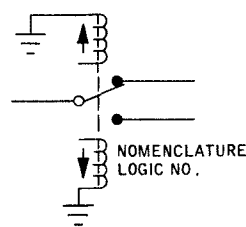

D. RELAY OR SOLENOID DRIVER

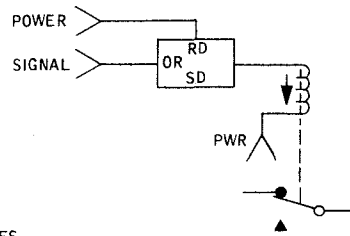

E. BUSES

1. SYMBOL (LENGTH MAY VARY)



2. DESIGNATION



F. GROUNDS

1. SYSTEM



2. FLOATING OR CONTROLLED

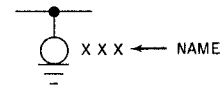

G. TRANSFORMERS

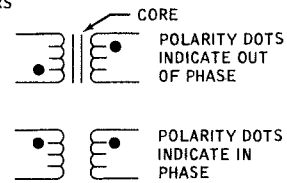

H. CAPACITOR

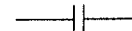

I. DIGITAL INVERTER

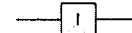

J. GATES

1. AND

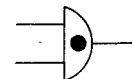

2. NAND

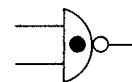

3. OR

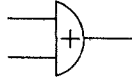

4. NOR

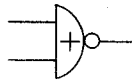

K. TIME DELAY

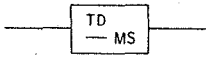

L. ELECTRICAL FILTER



M. MODULATOR

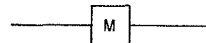

N. DEMODULATOR

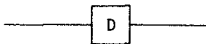

O. TRANSISTORS

1. NPN

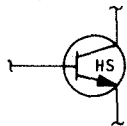

NOTE: WHEN SHOWN, HS DENOTES HEAT SINK MOUNTED.

2. PNP

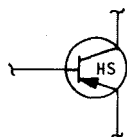

3. UNIUNCTION TRANSISTOR (UJT)

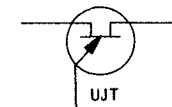

P. NON-AMPLIFYING DEVICE, IDENTIFIED

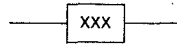

Q. DIODES

1. GENERAL



2. ZENER



3. CONTROL RECTIFIER



R. POTENTIOMETER

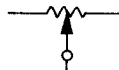

S. HEATER



T. FIXED RESISTOR

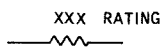

U. THERMISTOR

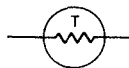

V. THERMOSTAT

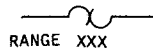

W. ANTENNA

NAME
(TYPE OR FUNCTION)



X. PHOTOELECTRIC CELL

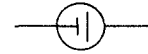

Y. AMPLIFIER

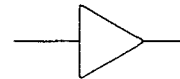
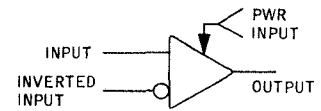

DC, PRE-, OR BUFFER AMPLIFIER
AS INDICATED

Z. CIRCUIT BREAKERS

1. AUTOMATIC

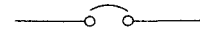

2. TWO-POLE, DOUBLE-THROW,
AUTOMATIC

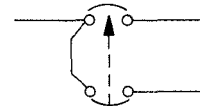

1.2.5 PYROTECHNIC SYMBOLS

A. EXPLOSIVE INITIATOR



1.2.6 SPECIAL ALSEP SYMBOLS

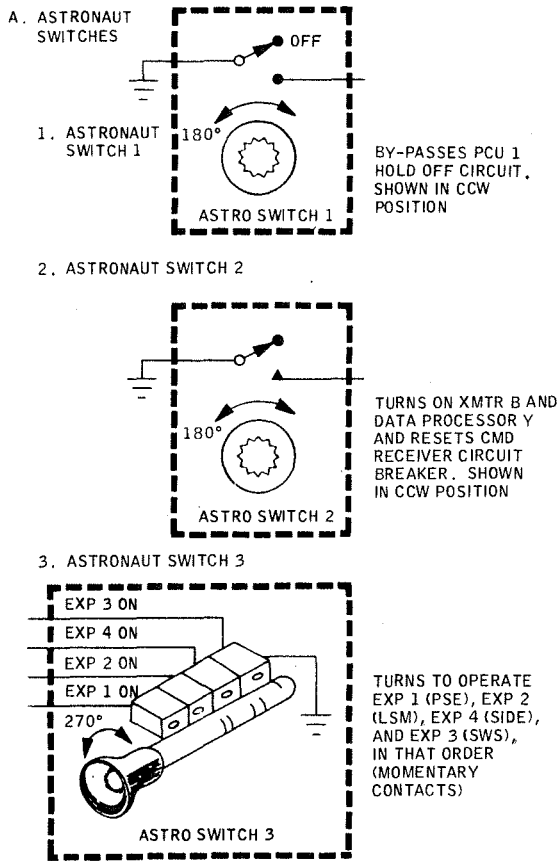

B. SIDE SENSOR ASSEMBLY

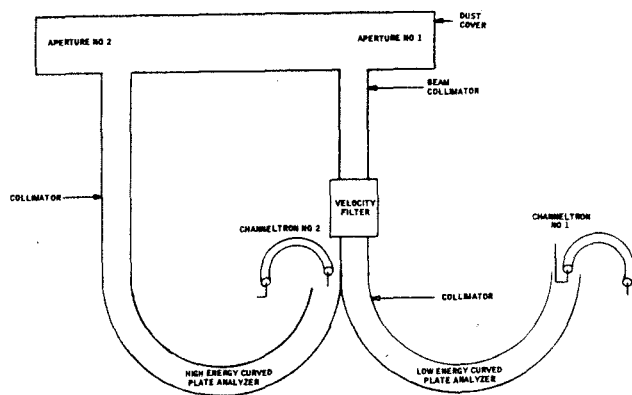

C. GROUND PLANE (USED ON SIDE)

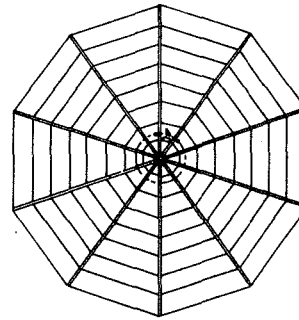

D. FARADAY CUP (SWS SENSOR)

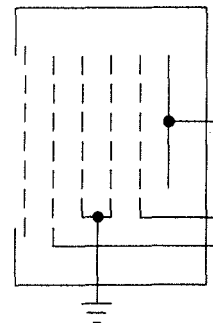

E. COLD CATHODE ION GAGE

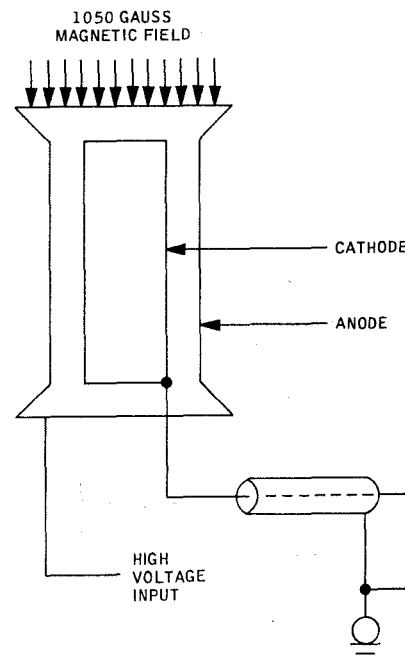

F. MOTOR (USED IN PSE AND LSM)

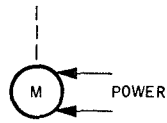

G. HEAT FLOW EXPERIMENT PROBE SECTION

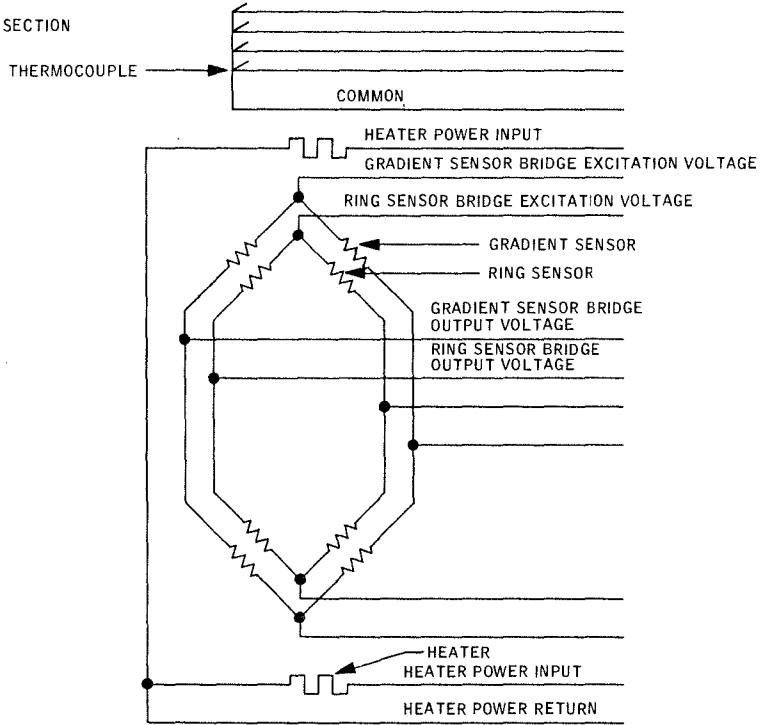

H. CHARGED PARTICLE LUNAR ENVIRONMENT EXPERIMENT

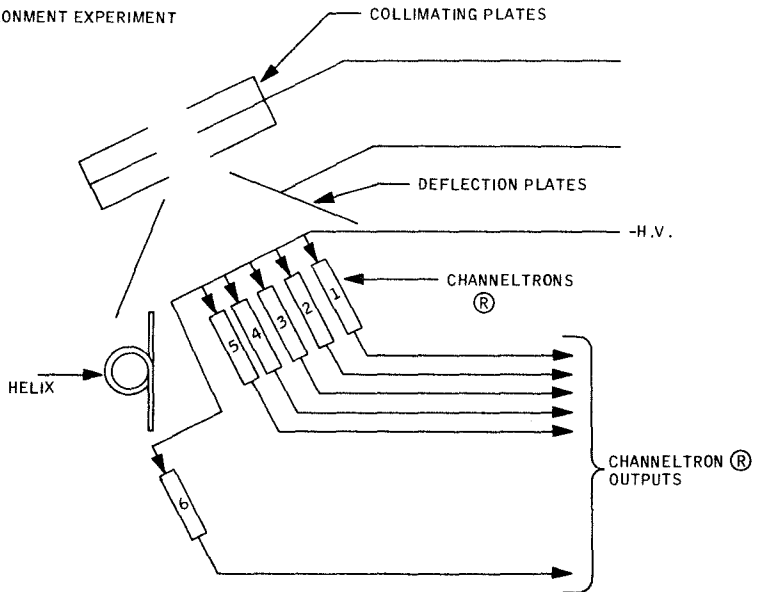

2 GENERAL
DESCRIPTION

SECTION 2
GENERAL DESCRIPTION

2.1 ALSEP DESCRIPTION

The Apollo lunar surface experiments package (ALSEP) system consists of a set of scientific instruments to be placed on the moon's surface by the Apollo flight crew. These instruments will remain on the moon to collect and transmit data for a design goal period of two years. For self-sufficient operations, the ALSEP system includes a nuclear power supply, mechanical support, thermal protection, and data handling equipment. These supporting subsystems provide a central station containing the electrical power, command, telemetry, and structural/thermal subsystems to operate with the following scientific experiment subsystems: passive seismic, active seismic, magnetometer, and heat flow.

2-2

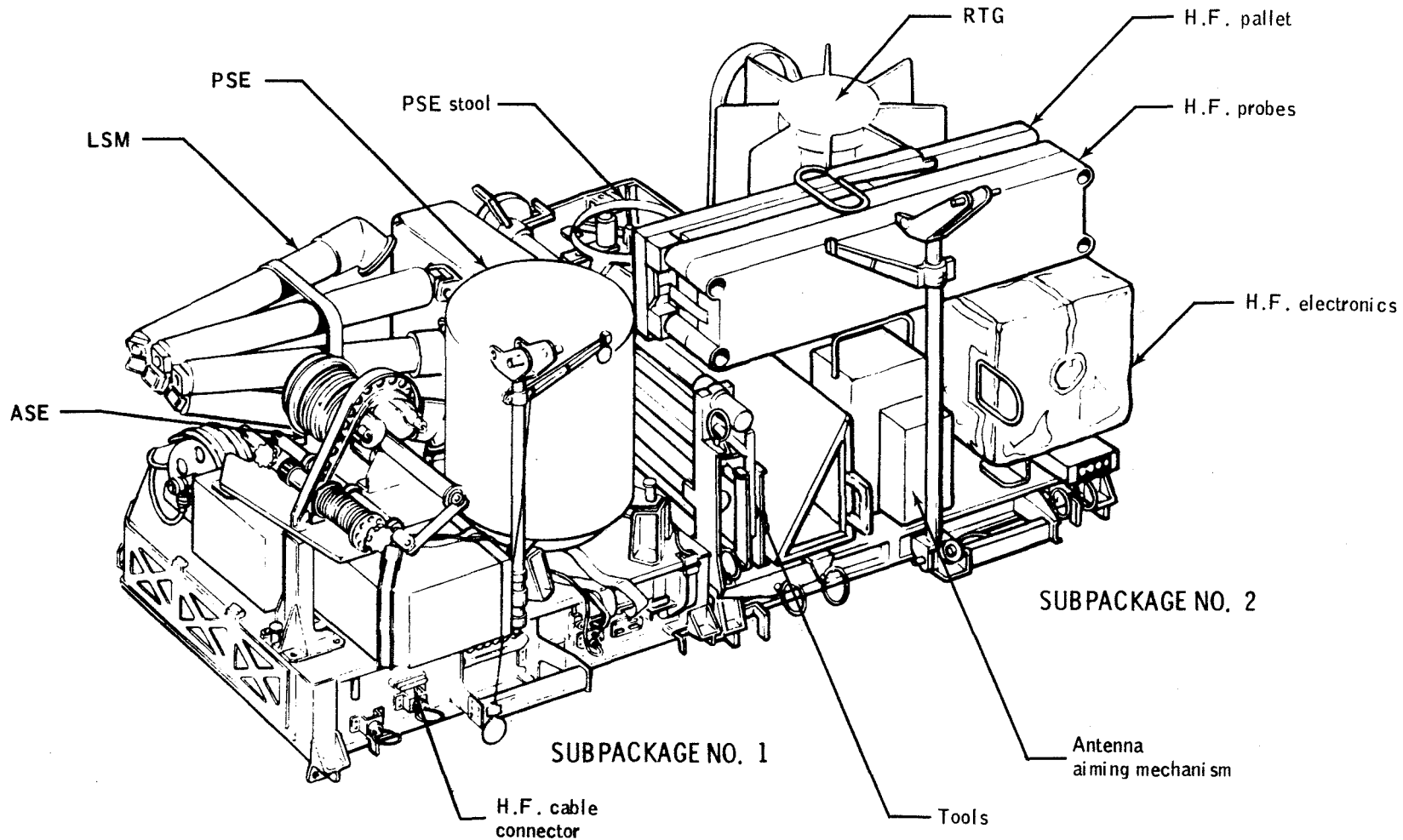
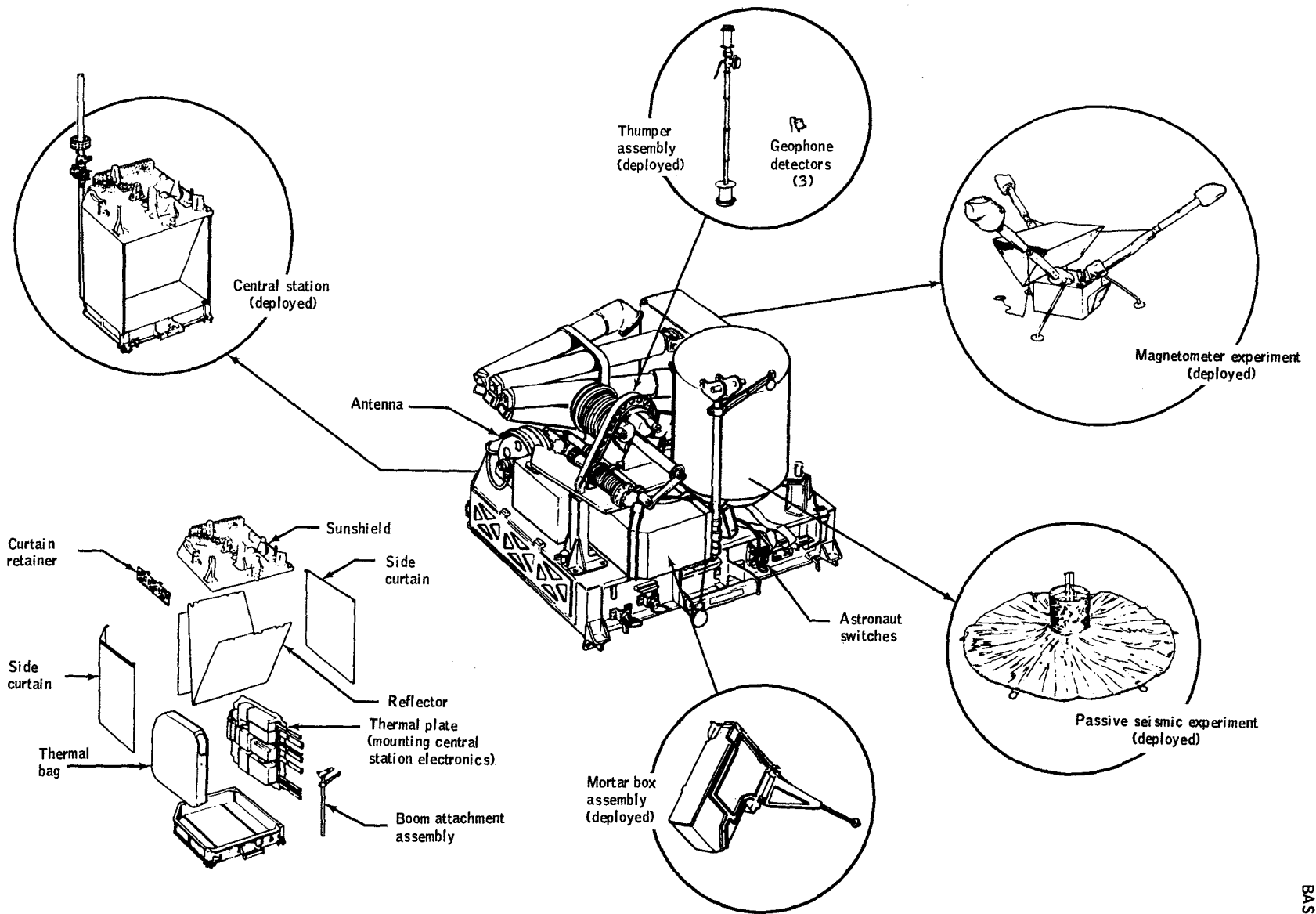

Figure 2-1.- ALSEP 3 (Array "D").

2-3



Structure/thermal subsystem components

Figure 2-2.- ALSEP Subpackage 1.

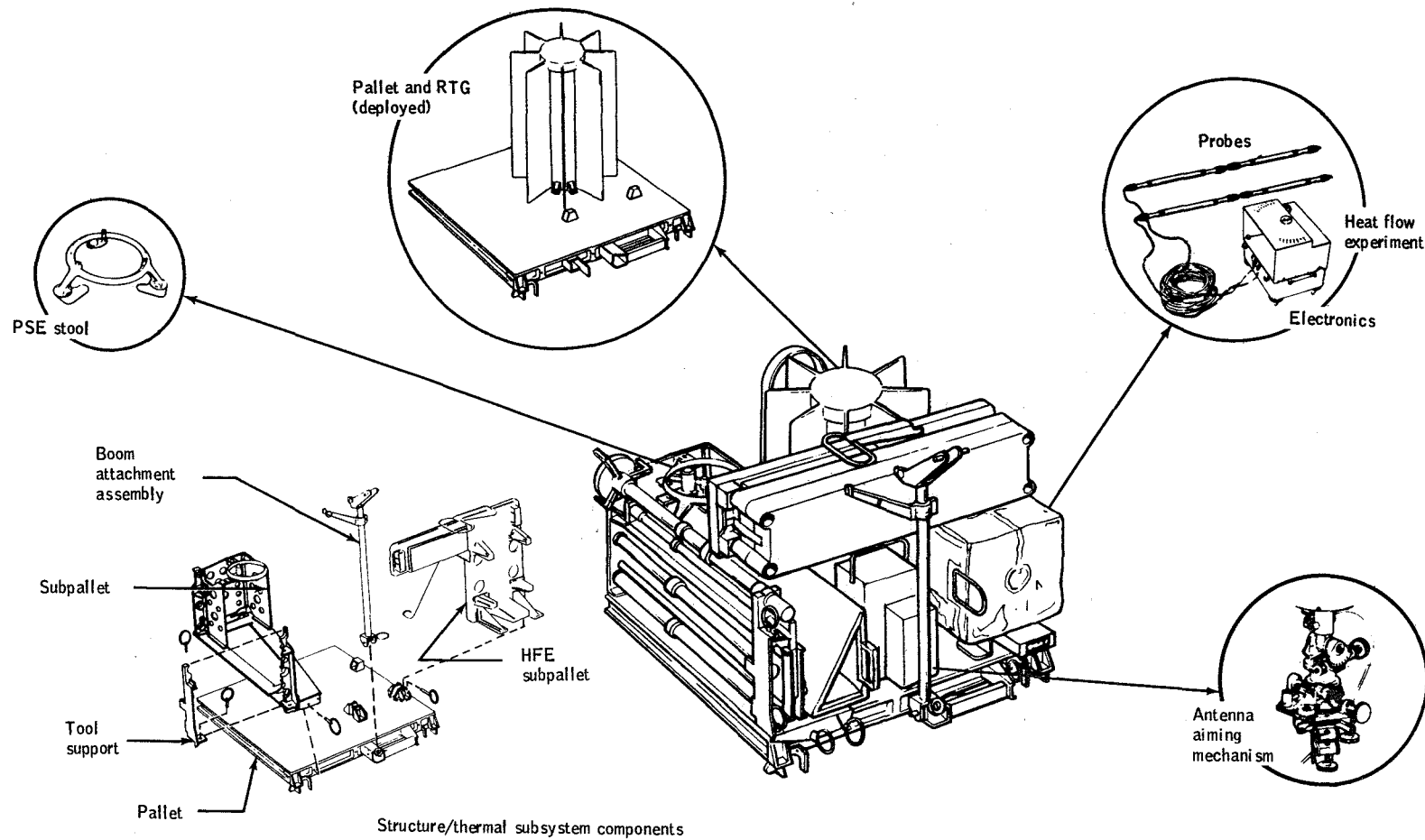
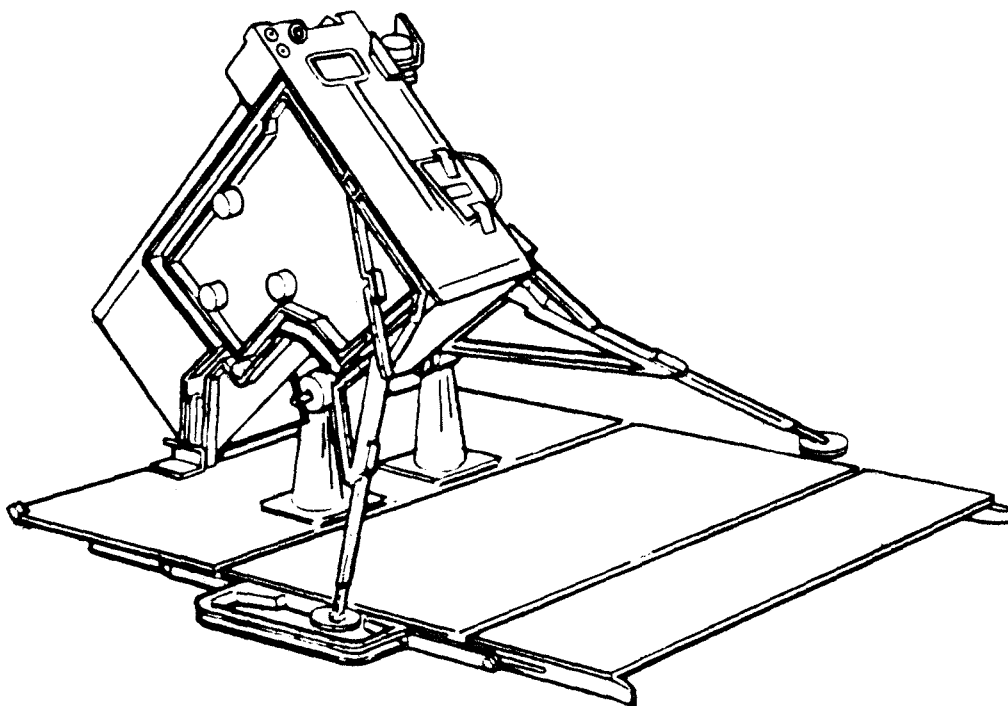

Figure 2-3. A1sep subpackage 2.



See drawing 2339380 (Bendix) for details

Figure 2-4. - Mortar package pallet

3 STRUCTURAL /
THERMAL CNTL
SUBSYSTEM

D

C

B

A

LTR	PCN	DR	ENGR	DATE	APPROVAL

COMMENTS:

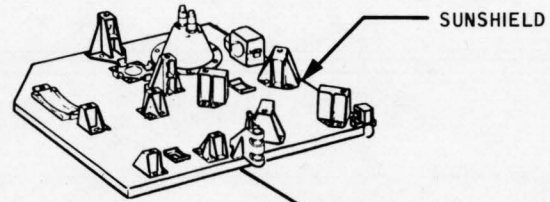

SUNSHIELD

LH GNOMON ASSEMBLY

AT-2
SUNSHIELD 2
DEG F
-300° F TO +300° F
CH-42

AT-1
SUNSHIELD 1
DEG F
-300° F TO +300° F
CH-27



CENTRAL STATION LEVELING BUBBLE

CENTRAL STATION SHADOW GRAPH

RH GNOMON ASSEMBLY

SIGNATURES		DATE	NATIONAL AERONAUTICS & SPACE ADMINISTRATION MANNED SPACECRAFT CENTER · HOUSTON, TEXAS		
DR			SUNSHIELD		
DSGN	<i>Martin Cole</i>	1-12-72			
QC	<i>Betty M. Saylor</i>	1-12-72			
ENGR	<i>J. F. Moore</i>	1-12-72			
APP	<i>W. D. Smith</i>	1-12-72	ALSEP 3	SIZE	DWG NO
STC	<i>David B. Fisher</i>	1-12-72	APOLLO 16	C₁	3.1
			22 X 17	PAGE 3-1	SHEET 1 OF 1

LTR	PCN	DR	ENG	DATE	APPROVAL
COMMENTS:					

LEGEND
 THERMISTOR LOCATION SYMBOL
 THERMISTOR LOCATION THERMAL PLATE

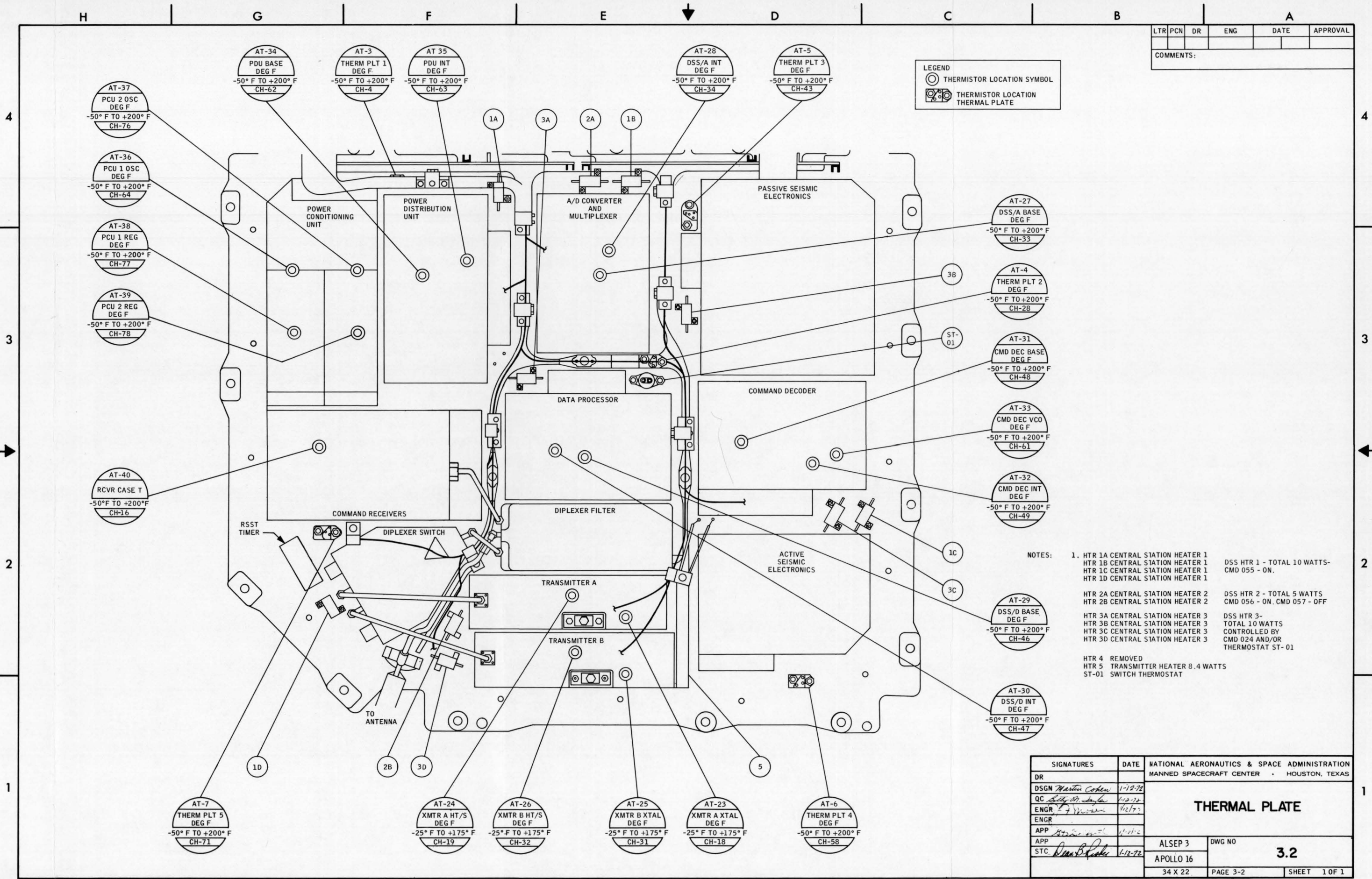

- NOTES:
- HTR 1A CENTRAL STATION HEATER 1
HTR 1B CENTRAL STATION HEATER 1
HTR 1C CENTRAL STATION HEATER 1
HTR 1D CENTRAL STATION HEATER 1
DSS HTR 1 - TOTAL 10 WATTS-
CMD 055 - ON.
 - HTR 2A CENTRAL STATION HEATER 2
HTR 2B CENTRAL STATION HEATER 2
DSS HTR 2 - TOTAL 5 WATTS
CMD 056 - ON. CMD 057 - OFF
 - HTR 3A CENTRAL STATION HEATER 3
HTR 3B CENTRAL STATION HEATER 3
HTR 3C CENTRAL STATION HEATER 3
HTR 3D CENTRAL STATION HEATER 3
DSS HTR 3-
TOTAL 10 WATTS
CONTROLLED BY
CMD 024 AND/OR
THERMOSTAT ST-01
 - HTR 4 REMOVED
 - HTR 5 TRANSMITTER HEATER 8.4 WATTS
 - ST-01 SWITCH THERMOSTAT

SIGNATURES		DATE	NATIONAL AERONAUTICS & SPACE ADMINISTRATION MANNED SPACECRAFT CENTER HOUSTON, TEXAS	
DR				
DSGN	<i>Walter Cohen</i>	1-12-72		
QC	<i>Walter Cohen</i>	1-12-72		
ENGR	<i>Walter Cohen</i>	1-12-72		
APP	<i>Walter Cohen</i>	1-12-72		
STC	<i>Walter Cohen</i>	1-12-72		
			ALSEP 3	DWG NO
			APOLLO 16	3.2
			34 X 22	PAGE 3-2 SHEET 1 OF 1

H G F E D C B A

LTR	PCN	DR	ENGR	DATE	APPROVAL

COMMENTS:

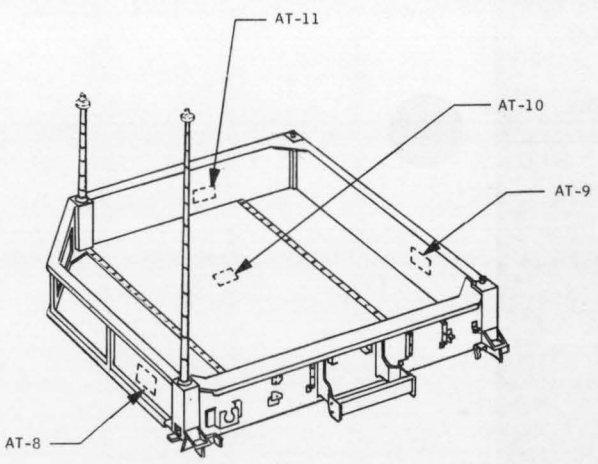

PRIMARY STRUCTURE

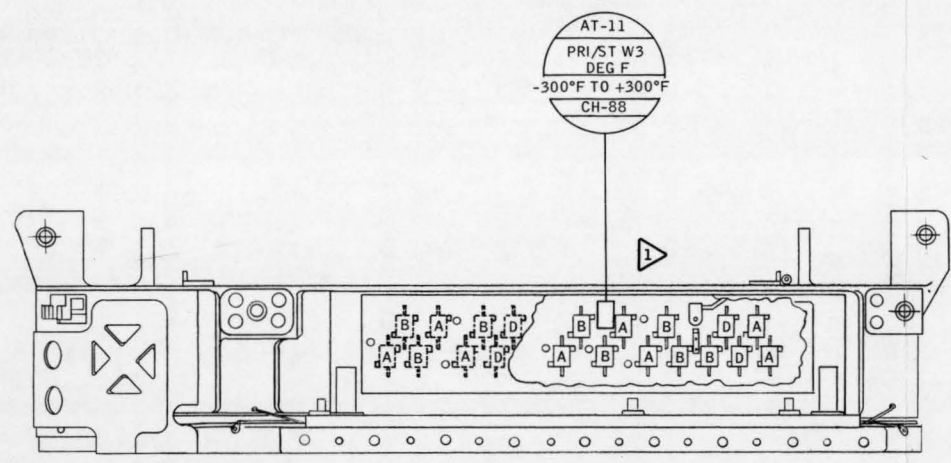

AT-11
PRI/ST W3
DEG F
-300°F TO +300°F
CH-88

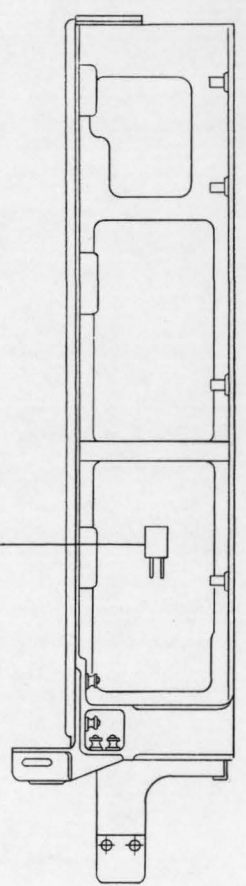

AT-8
PRI/ST W1
DEG F
-300°F TO +300°F
CH-59

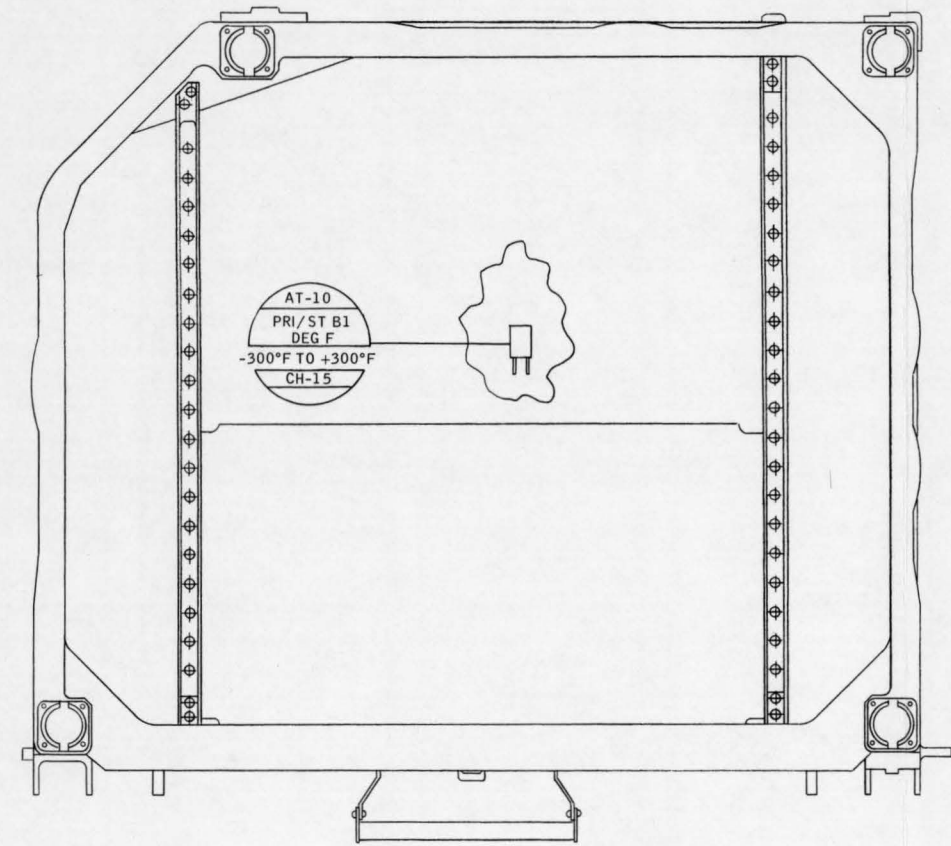

AT-10
PRI/ST B1
DEG F
-300°F TO +300°F
CH-15

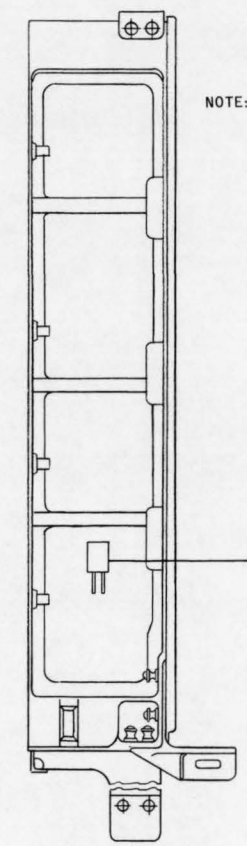

AT-9
PRI/ST W2
DEG F
-300°F TO +300°F
CH-87

NOTE: RESISTORS MARKED A - SHUNT REGULATOR 1
RESISTORS 3.57Ω TOTAL
RESISTORS MARKED B - SHUNT REGULATOR 2
RESISTORS 3.57Ω TOTAL
PDR 1 RESISTORS REMOVED
RESISTORS MARKED D - PDR 2 RESISTORS
60Ω TOTAL 14 WATTS

SIGNATURES	DATE	NATIONAL AERONAUTICS & SPACE ADMINISTRATION MANNED SPACECRAFT CENTER HOUSTON, TEXAS	
DR			
DSGN <i>Martin Cohen</i>	1-12-72		
QC <i>...</i>	1-12-72		
ENGR <i>...</i>	1/12/72		
APP <i>...</i>	1/21/72		
STC <i>Donna B. Parker</i>	1-12-72		
		ALSEP 3	SIZE DWG NO
		APOLLO 16	D 3.3
		34 X 22	PAGE 3-3 SHEET 1 OF 1

D

C

B

A

LTR	PCN	DR	ENGR	DATE	APPROVAL

COMMENTS:

4

4

3

3

2

2

1

1

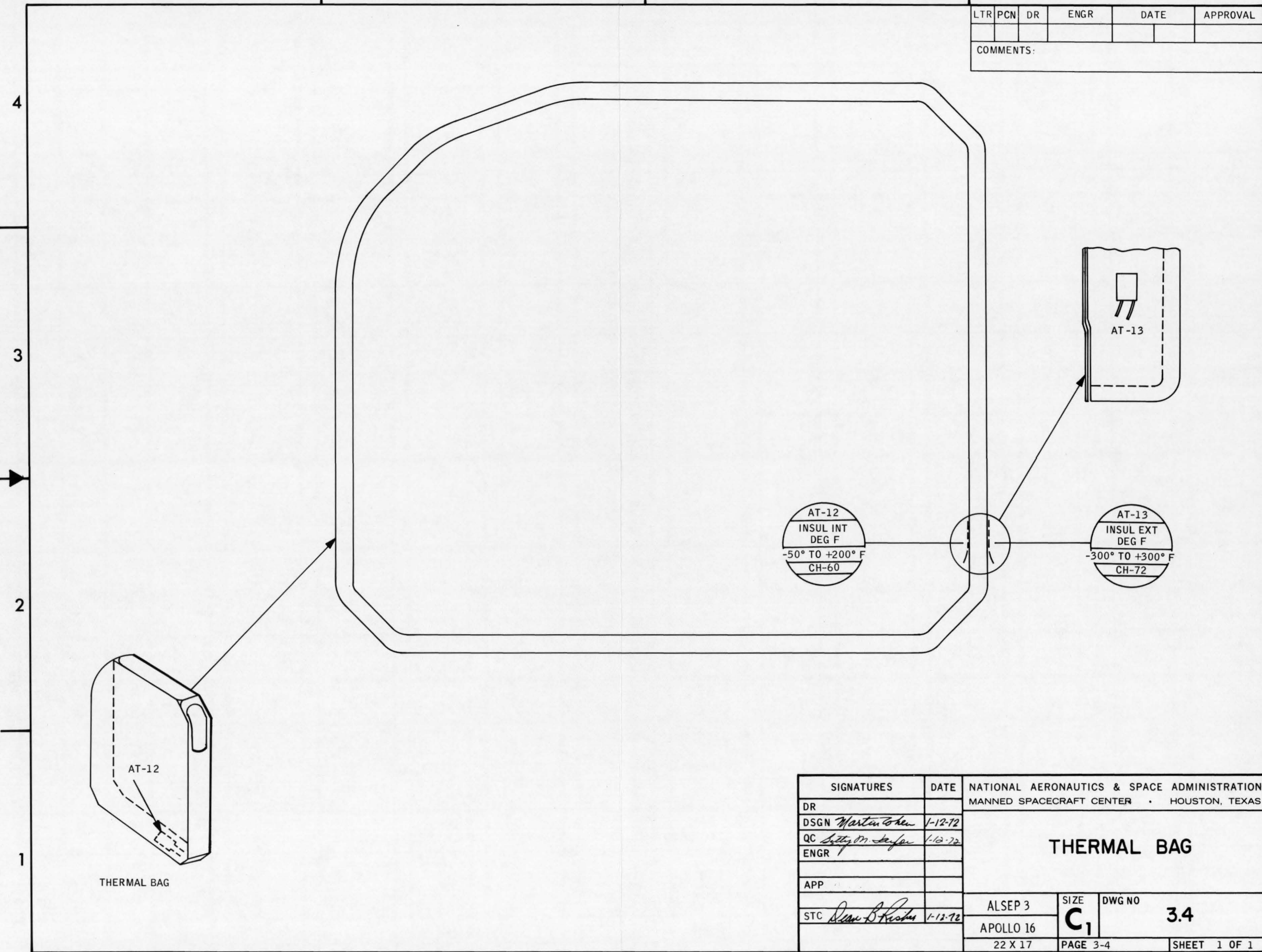

AT-12
INSUL INT
DEG F
-50° TO +200° F
CH-60

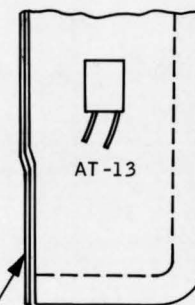

AT-13
INSUL EXT
DEG F
-300° TO +300° F
CH-72

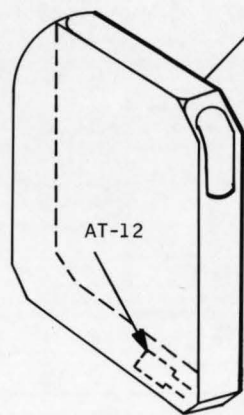

THERMAL BAG

SIGNATURES		DATE	NATIONAL AERONAUTICS & SPACE ADMINISTRATION	
DR			MANNED SPACECRAFT CENTER • HOUSTON, TEXAS	
DSGN <i>Martin Cohen</i>		1-12-72	THERMAL BAG	
QC <i>Betty M. Seifer</i>		1-12-72		
ENGR				
APP				
STC <i>Dean B. Fisher</i>		1-12-72	ALSEP 3	SIZE C₁ DWG NO 3.4
			APOLLO 16	
			22 X 17	PAGE 3-4 SHEET 1 OF 1

TR	PCN	DR	ENG	DATE	APPROVAL

COMMENTS:

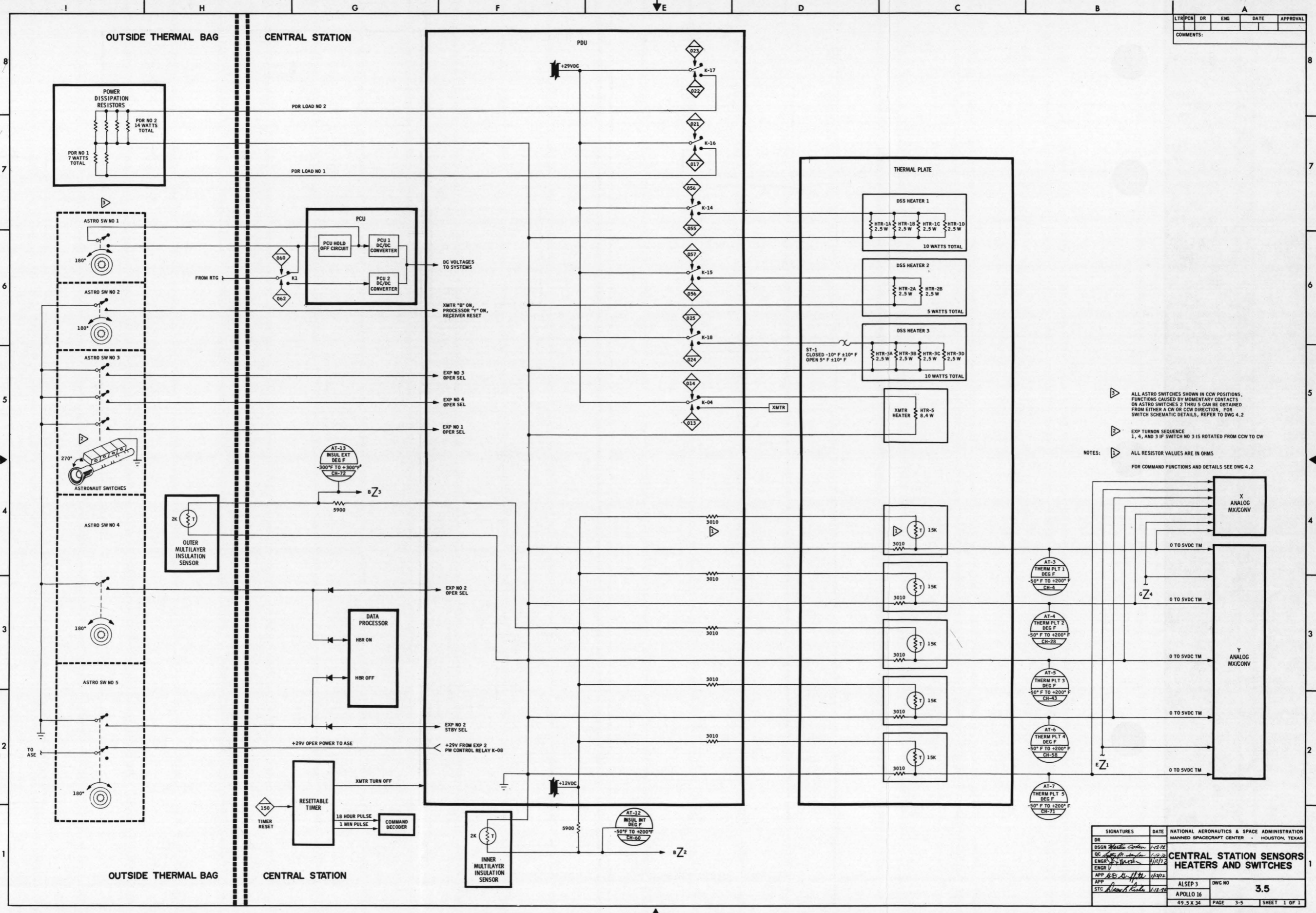

- NOTES:
- ▶ ALL ASTRO SWITCHES SHOWN IN CCW POSITIONS. FUNCTIONS CAUSED BY MOMENTARY CONTACTS ON ASTRO SWITCHES 2 THRU 5 CAN BE OBTAINED FROM EITHER A CW OR CCW DIRECTION. FOR SWITCH SCHEMATIC DETAILS, REFER TO DWG 4.2
 - ▶ EXP TURNON SEQUENCE 1, 4, AND 3 IF SWITCH NO 3 IS ROTATED FROM CCW TO CW
 - ▶ ALL RESISTOR VALUES ARE IN OHMS
- FOR COMMAND FUNCTIONS AND DETAILS SEE DWG 4.2

SIGNATURES	DATE	NATIONAL AERONAUTICS & SPACE ADMINISTRATION MANNED SPACECRAFT CENTER - HOUSTON, TEXAS	
DR			
DC	1/28/72		
ENGR	1/28/72		
ENGR	1/10/72		
APP	1/19/72		
STC	1/11/72		
		ALSEP 3	DWG NO
		APOLLO 16	3.5
		49.5 X 34	PAGE 3-5 SHEET 1 OF 1

**CENTRAL STATION SENSORS
HEATERS AND SWITCHES**

4 ELECTRICAL
POWER
SUBSYSTEM

*

SECTION 4
ELECTRICAL POWER SUBSYSTEM

4.1 SYSTEM DESCRIPTION

The electrical power subsystem provides the electrical power for lunar surface operation of the ALSEP. Primary electrical power is developed by thermoelectric action with thermal energy supplied by a radioisotope source. The primary power is converted, regulated, and filtered to provide the six operating voltages for the ALSEP experiment and support subsystems.

The components are a radioisotope thermoelectric generator assembly, a fuel capsule assembly, a power conditioning unit, and a power distribution unit.

4.1.1 Radioisotope Thermoelectric Generator (RTG)

- A. RTG commands - No command capability
- B. RTG telemetry - Six temperatures (refer to Drawing 4.1), one output voltage, and one output current (refer to Tables 6-VII and 6-VIII)
- C. Output - 68 watts, nominal (refer to Figure 4-1)

4.1.2 Power conditioning Unit (PCU)

The PCU performs three major functions:

- A. Voltage conversion
- B. Voltage regulation
- C. RTG protection

Each power conditioner consists of a dc-to-dc power converter (inverter and rectifiers), which converts the RTG 16-volt input to the six operating voltages, and a shunt current regulator to maintain the output voltages within approximately ± 1 percent. The input voltage is also regulated by this action by maintaining a constant load on the RTG. It is necessary to keep

D

C

B

A

4

4

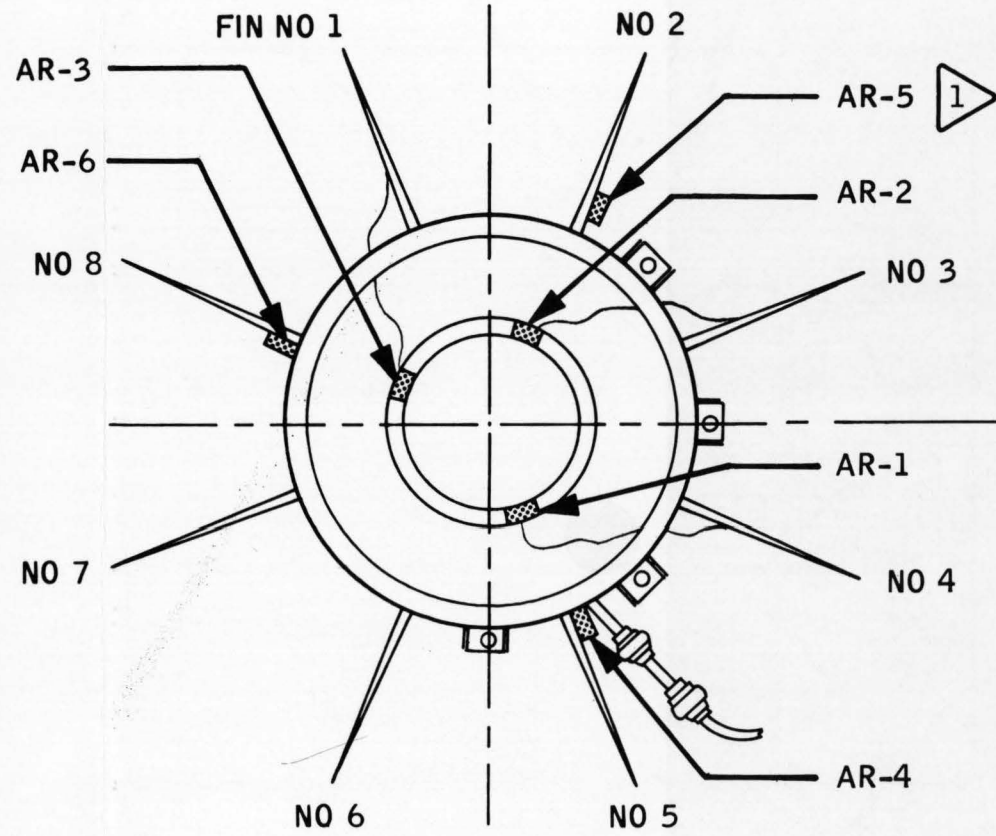

TOP VIEW
TM
DESIGNATIONS

- AR-1 HOT FRAME 1
- AR-2 HOT FRAME 2
- AR-3 HOT FRAME 3
- AR-4 COLD FRAME 1
- AR-5 COLD FRAME 2
- AR-6 COLD FRAME 3

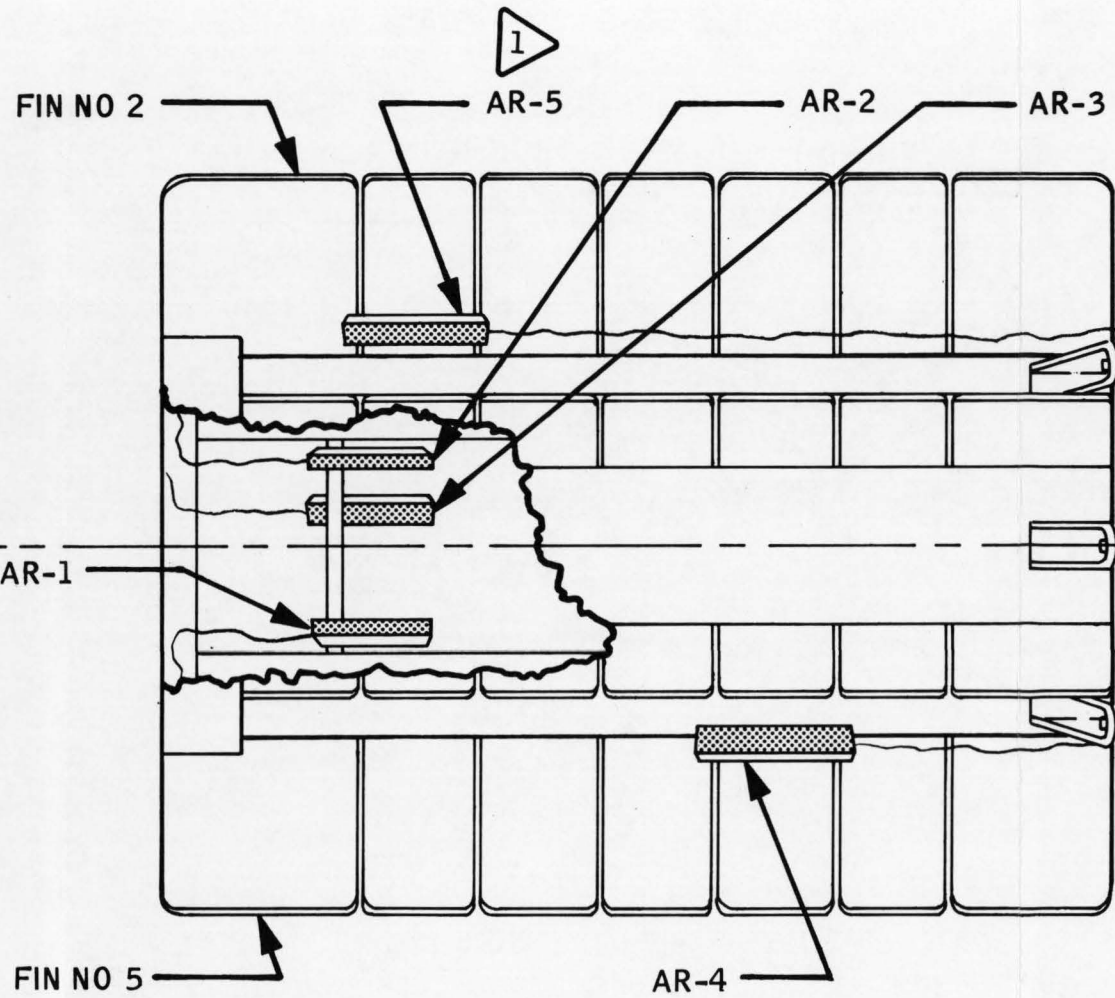

SIDE VIEW

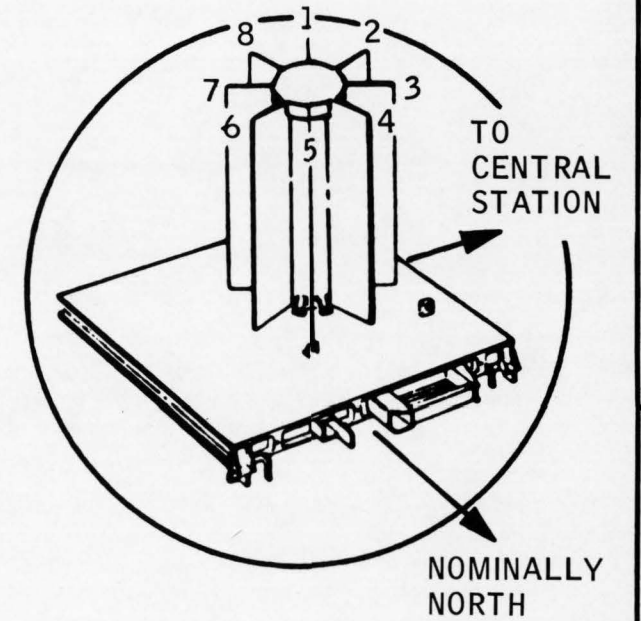

NOTES: INOPERATIVE PARAMETER

2

2

1

1

SIGNATURES		DATE	NATIONAL AERONAUTICS & SPACE ADMINISTRATION MANNED SPACECRAFT CENTER • HOUSTON, TEXAS	
DR			RTG TEMPERATURE SENSOR LOCATIONS	
DSGN	<i>Martin Cohen</i>	1-12-72		
QC	<i>Betty M. Taylor</i>	1-12-72		
ENGR	<i>J. F. Moore</i>	1/14/72		
APP	<i>D. S. ...</i>			
STC	<i>Dean B. ...</i>	1-10-72	ALSEP 3	SIZE B₁
			APOLLO 16	DWG NO. 4.1
			17 X 10.5	PAGE 4-2 SHEET 1 OF 1

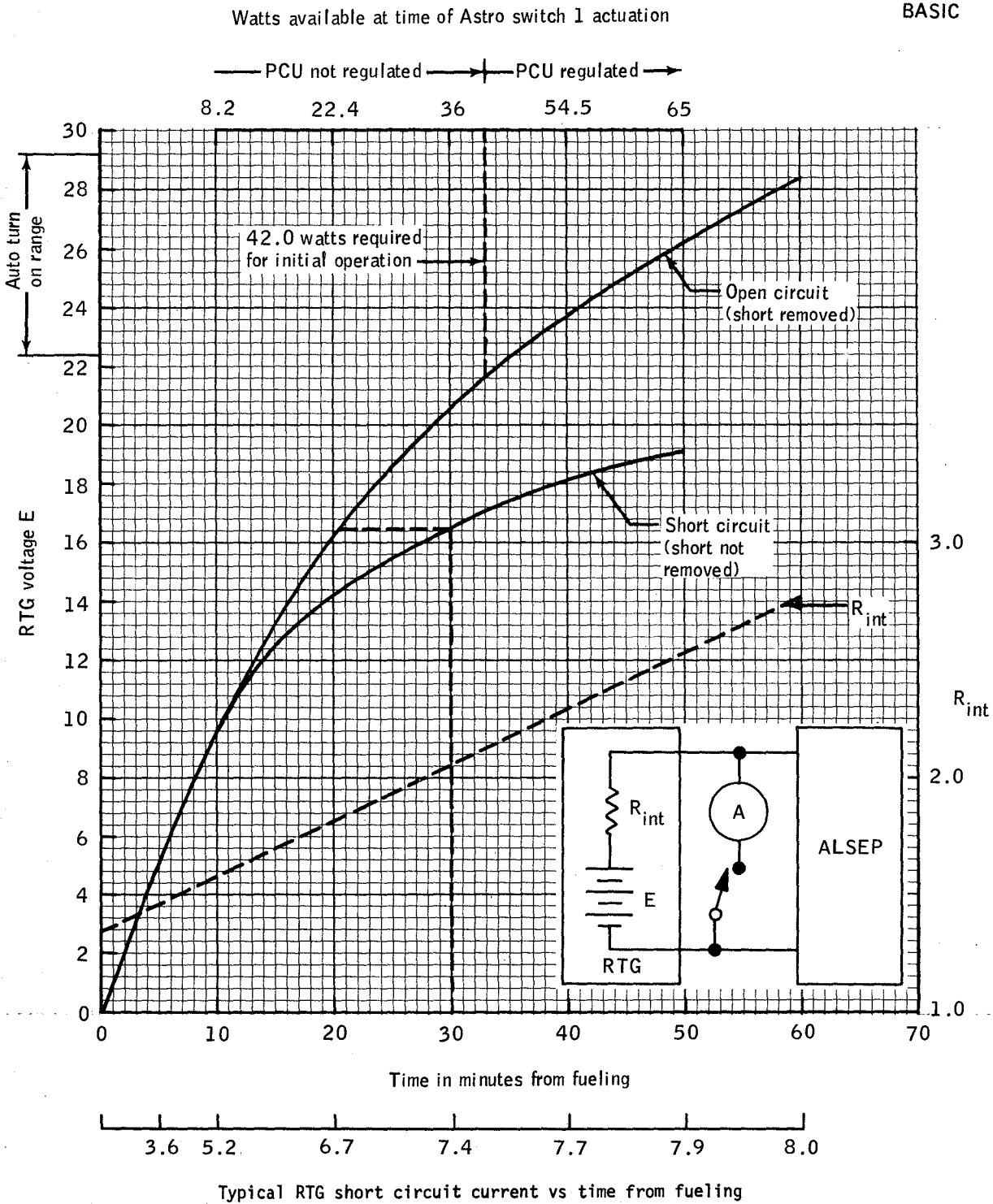

Example:

Short removed 30 minutes after fueling. Move horizontally from short circuit curve to open circuit curve. If Astronaut switch no. 1 is actuated 13 minutes later, the required 42.0 watts will be available.

Figure 4-1. - RTG warmup characteristics.

*

a constant load on the generator to prevent overheating of the thermocouples in the RTG.

The +16 volts from the RTG is applied through the switching circuit to the selected dc-to-dc converter, applying power to the inverter and completing the shunt regulation circuit. Applying power to the inverter permits it to supply ac power to the rectifiers that develop the dc voltages applied to the filters. The outputs from the filters are the six operating voltages applied to the data subsystem and experiments. Output and input voltages are regulated by feedback from the +12-volt output to the shunt regulator. The +12-volt feedback is also applied to the switching circuit for over or under voltage determination for automatic switching to the redundant inverter and regulator, if necessary. All the output voltages are regulated by the 12-volt feedback.

4.1.3 Power Distribution Unit (PDU)

The PDU distributes power to experiment and central station subsystems and provides circuit overload protection and power switching of selected circuits. The PDU also provides signal conditioning of selected central station and RTG telemetry signals prior to input to the analog multiplexer for analog-to-digital conversion and subsequent data transmission to earth.

4.1.3.1 Power-off sequencer.— (Refer to Figure 4-2.) The power-off sequencer of the PDU detects minimum reserve power and sequentially turns to standby up to three preselected experiments to bring the reserve power within acceptable limits. The reserve power parameter is not downlinked as such, but is calculated from TM parameters AE-3 (PCU IN VOLTS) and AE-5 (PCU 1 SHUNT AMPS):

$$(AE-3) (AE-5) = \text{Reserve power}$$

FCD 2-71.23.68

4-5

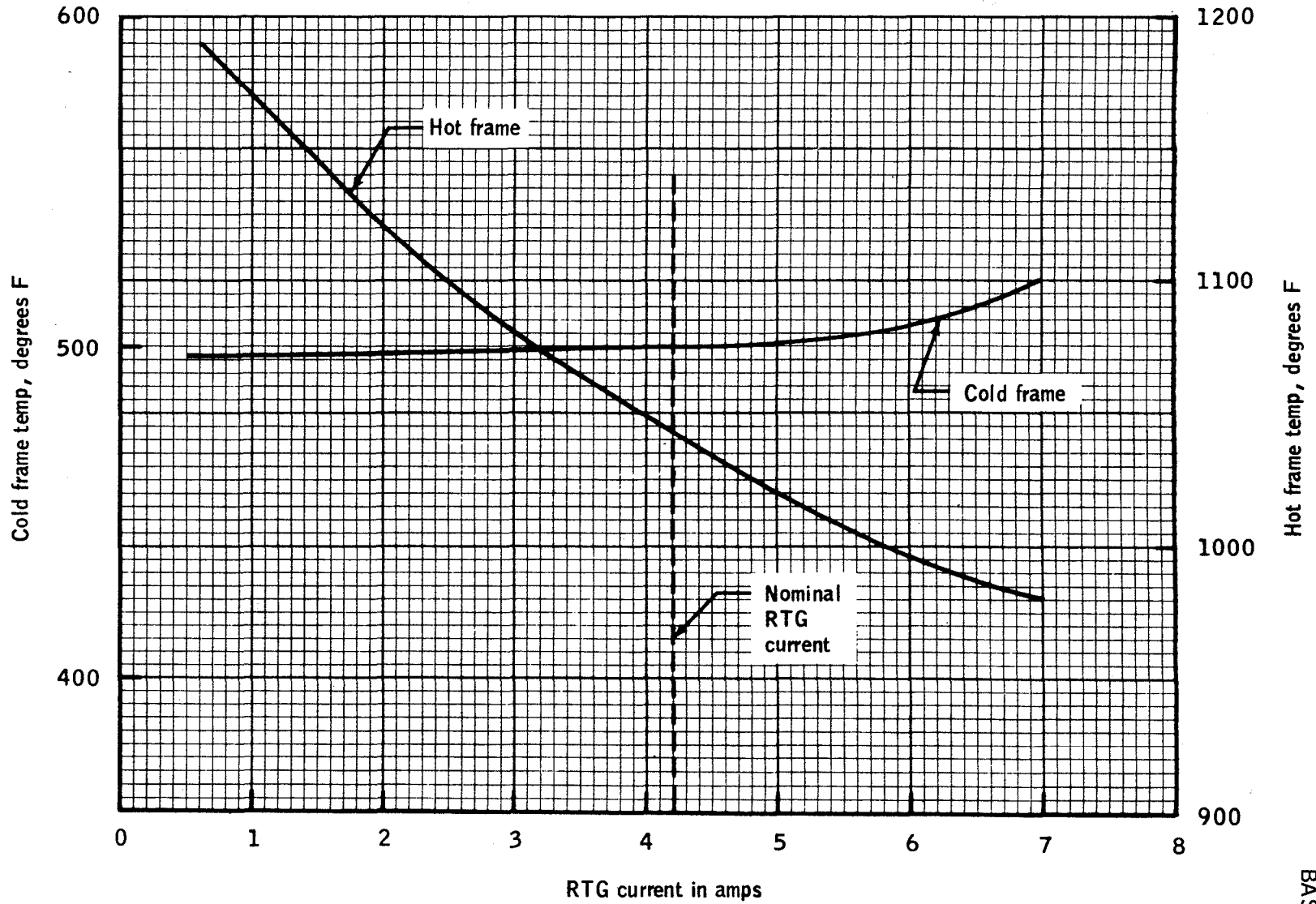

Figure 4-2. - RTG hot and cold frame temps vs RTG current (typical).

*

(AE-3) (AE-6), when PCU 2 is operational. The minimum reserve power is detected by monitoring the voltage across the shunt regulator transistor. This voltage is applied to an operational amplifier used as a level detector. An RC delay network is employed at the output of the level detector. The output of the delay is applied to a second level detector which drives the power-off sequencer logic. This arrangement turns on the power-off sequencer logic input gate when the reserve power/shunt current drops below the following levels:

- A. Reserve power/shunt current to start experiment turnoff (135-ms delay): $\underline{0.78} \pm \underline{0.57}$ watts (AE-3 assumed to be constant at 16.0 volts)
- B. SHUNT CURRENT (AE-5 or AE-6): $\underline{.048} \pm \underline{.035}$ amp

Experiment turnoff sequence, via the power-off sequencer, is as follows:

- A. Experiment 4 (HFE)
- B. Experiment 3 (LSM)
- C. Experiment 1 (PSE)

NOTE

Experiment 2 (ASE) is not in the ripple off sequence.

The sequencer decoding gates are connected so that upon turn-on of the logic input gate, an output ground level signal is provided during the count between 1 and 9 milliseconds to the HFE power standby relay driver. This relay removes experiment operate power and applies power to the standby line. If the overload persists, the ground level signal supplied to the HFE standby line is removed and a ground level signal is applied to

*

the LSM power standby command input during the next 8-millisecond period (when the count is between 9 and 17 milliseconds). If overloading persists, the sequencer could continue in the same manner until the passive seismic experiment (PSE) is in the standby mode. If, however, the overload is removed within the sequence, the counter will be reset in 2 milliseconds after a satisfactory power reserve signal is obtained, thus stopping the sequence. Note that the power-off sequencer action places the experiments to STBY ON from either an OPER ON condition or from a STBY OFF condition.

4.1.3.2 Temperature sensor circuit.- Operational amplifiers are used to amplify the resistive bridge outputs for the RTG hot and cold junction temperatures. The temperature sensors located on the RTG are platinum wire sensors (see Drawing 4.1). Bridge excitation is 12 Vdc on both the hot and cold frame temperature circuits.

Nickel wire temperature sensors are used in dividers to monitor exposed structural temperature, multilayer bag insulation temperatures, and sunshield temperatures. The circuit is a simple divider consisting of 12 Vdc supplied through 5900 ohms and the sensor to ground. The output analog signal is taken across the sensor, providing a linear response from -300° to $+300^{\circ}$ F. (Refer to Section 3 for sensor locations.)

Thermistor sensors are provided to monitor temperatures within the central station and subsystems. The sensor ranges are between -50° and $+200^{\circ}$ F (See Drawing 3.2).

4.1.3.3 Power control.- (Refer to Drawing 4.2.) Power control is provided by ground commands and/or astronaut switch functions causing the command lines to go to ground potential, thus actuating relay drivers and their associated relays.

*
Four transistorized relay drivers, magnetic latching relays, and one magnetic latching relay acting as an overload sensor (circuit breaker) perform the control and circuit protection function for each experiment. The experiment standby power line is fused at 500 mA. Three command inputs are provided for each experiment power control circuit:

- A. Experiment operate select
- B. Experiment standby select
- C. Experiment standby off

The three command inputs operate one or both of two power switching relays. One relay provides the selection of either standby power or operational power. The other interrupts the standby power line. The receipt of an experiment operate select command will transfer the relay to a position which provides power through the current sensing coil of the circuit breaker relay to the experiment electronics. A second command, standby off, operates the relay coil of the standby power interruption relay to open the circuit supplying power to the standby line. The standby select command, however, operates on both relays. The standby select command actuates both relays to the positions that supply power to the standby line. To place an experiment from operate to standby off, the standby select command must be executed prior to the standby off command.

Circuit breaker resetting is provided by internally generating a standby select command using the contacts of a current sensing relay. Should an overcurrent condition exist through the sensing coil in series with the experiment operational power line, the contacts of the sensing relay break the standby select command line and apply a ground signal to each of two relay drivers. One relay driver operates the power

*
select relay to the standby power position. The other driver operates the standby power interruption relay to close the contacts supplying power to the standby power line. Operation of the standby power interruption relay provides power to the reset coil of the overload sensing relay thereby resetting its contacts to permit normal standby select command inputs.

Transmitter power control and overload protection uses two power control relays, four overload sensing relays, and associated relay drivers. Four commands are required:

- A. Transmitter on
- B. Transmitter off
- C. Transmitter A select
- D. Transmitter B select

The transmitter on and off commands operate the double-pole double-throw relay K-04, which switches both +12 Vdc and +29 Vdc to the transmitter select relay K-05. When the transmitter is off, +29 Vdc is switched to the 8.4-watt transmitter heater. Of either transmitter A or transmitter B +29 Vdc power line is overloaded, the contacts of the overload sensing relay transfer the transmitter select relay to supply power to the alternate transmitter. When power is transferred to the alternate transmitter, the circuit overload sensing relays are both reset and the normal command inputs are restored. Diplexer switching power, required only when transmitter B is selected, is obtained directly from the +12 Vdc transmitter B power line. Note that the transmitters do not use +12 Vdc.

The command receivers require +12 Vdc for operation. The +12 Vdc line is provided with overload protection using parallel 125 MA fuses.

ALSEP 3
BASIC

For data processor power control, redundant electronics are switched using standard magnetic latching relays. These relays are controlled by ground commands. Overload protection is not provided.

DSS heater 1, 2, & 3, power dissipation resistors 1 & 2, are switched off and on by ground command only. DSS heater 3 is thermostatically controlled.

TABLE 4-I.- PCU OVER AND UNDER VOLTAGE

[Over and under voltage sensing circuit - an automatic switchover circuit in PCU 1 which operates when the +12 Vdc bus varies outside the following limits. The sensing circuit causes a switch from PCU 1 to PCU 2]

Sensing circuit	Voltage level	Time delay
Over voltage	+13 ± 0.25 Vdc	10 ms
Under voltage	+11 ± 0.25 Vdc	300 ms

TABLE 4-II.- POWER CALCULATIONS

<u>TM symbol</u>	<u>Resultant (watts)</u>
(AE-3)(AE-4)	= RTG output power
(AE-3)(AE-5)	= Reserve power PCU 1
(AE-3)(AE-6)	= Reserve power PCU 2
(RTG output power) - (Reserve power)	= PCU input power
(AE-3)(AE-5) - (AE-5) ² (4.2 Ω)	= Internal reg 1 dissipation
(AE-3)(AE-6) - (AE-6) ² (4.2 Ω)	= Internal reg 2 dissipation

*

TABLE 4-III.- PDU RELAY INITIAL CONDITIONS

[Initial condition is defined as the relay positions at time of activation on the lunar surface]

Relay	Function	Monitor	Initial condition
K-01	PCU select	AE-5	PCU 1 selected
K-02, K-03	D/P select	AB-6	D/P X selected
K-04	Xmtr, xmtr htr select	Downlink	Xmtr on
K-05	Xmtr A, xmtr B select	AE-17	Xmtr A selected
K-06, K-07	Exp 1 power control	AB-4	Exp 1 in stby
K-08, K-09	Exp 2 power control	AB-4	Exp 2 in stby ^a
K-10, K-11	Exp 3 power control	AB-5	Exp 3 in stby
K-12, K-13	Exp 4 power control	AB-5	Exp 4 in stby
K-14, K-15	DSS htr 1 & 2 power control	AB-5	DSS htr 2 off
K-16	PDR 1 on/off	AE-5	Off
K-17	PDR 2 on/off	AE-5	Off
K-18	DSS heater 3 on/off	AE-5	Off
K-19	Receiver protection	Command capability	Receiver on

^aExp 3 (LSM) has no standby heater.

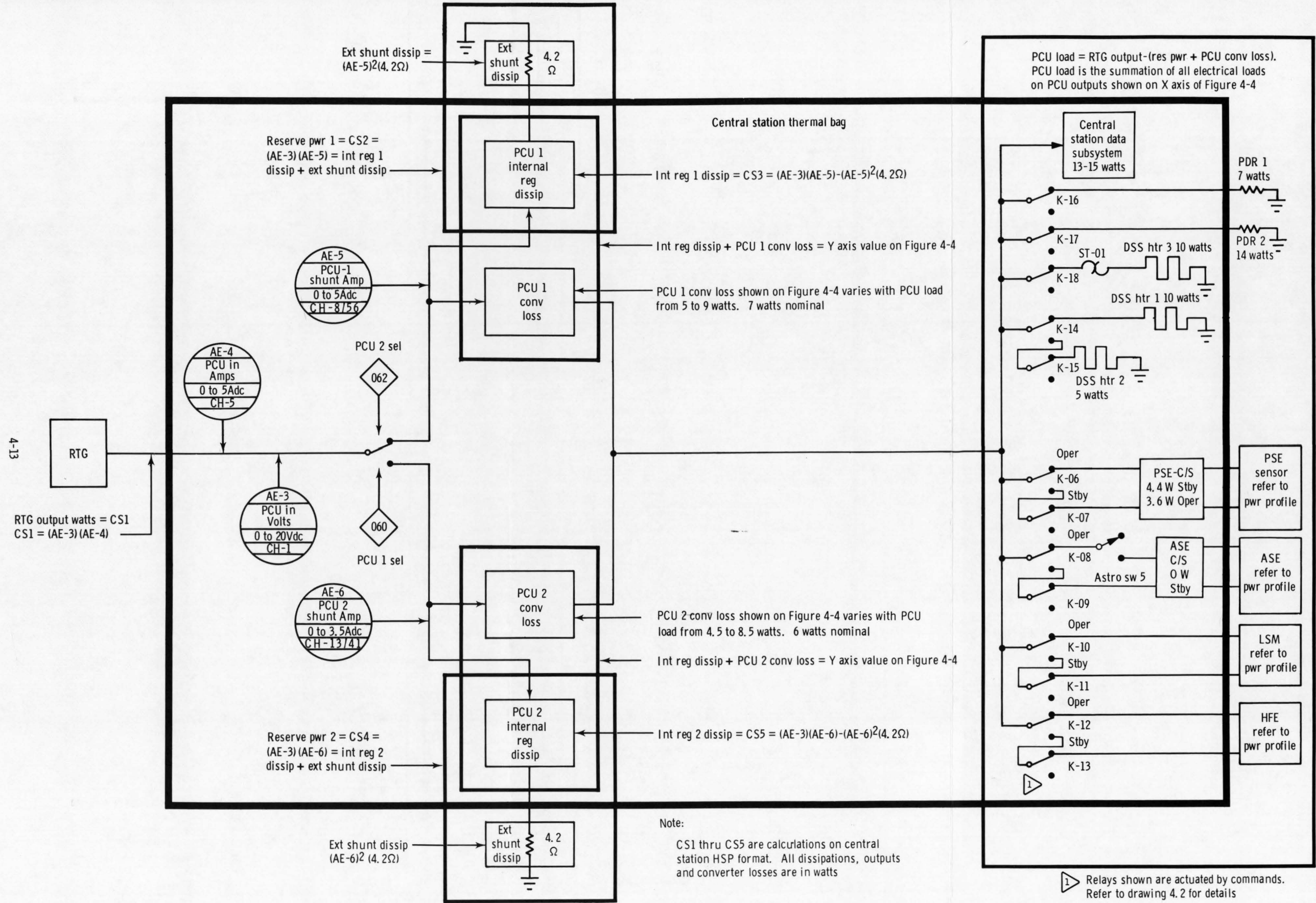

Figure 4-3. - ALSEP 3 power distribution.

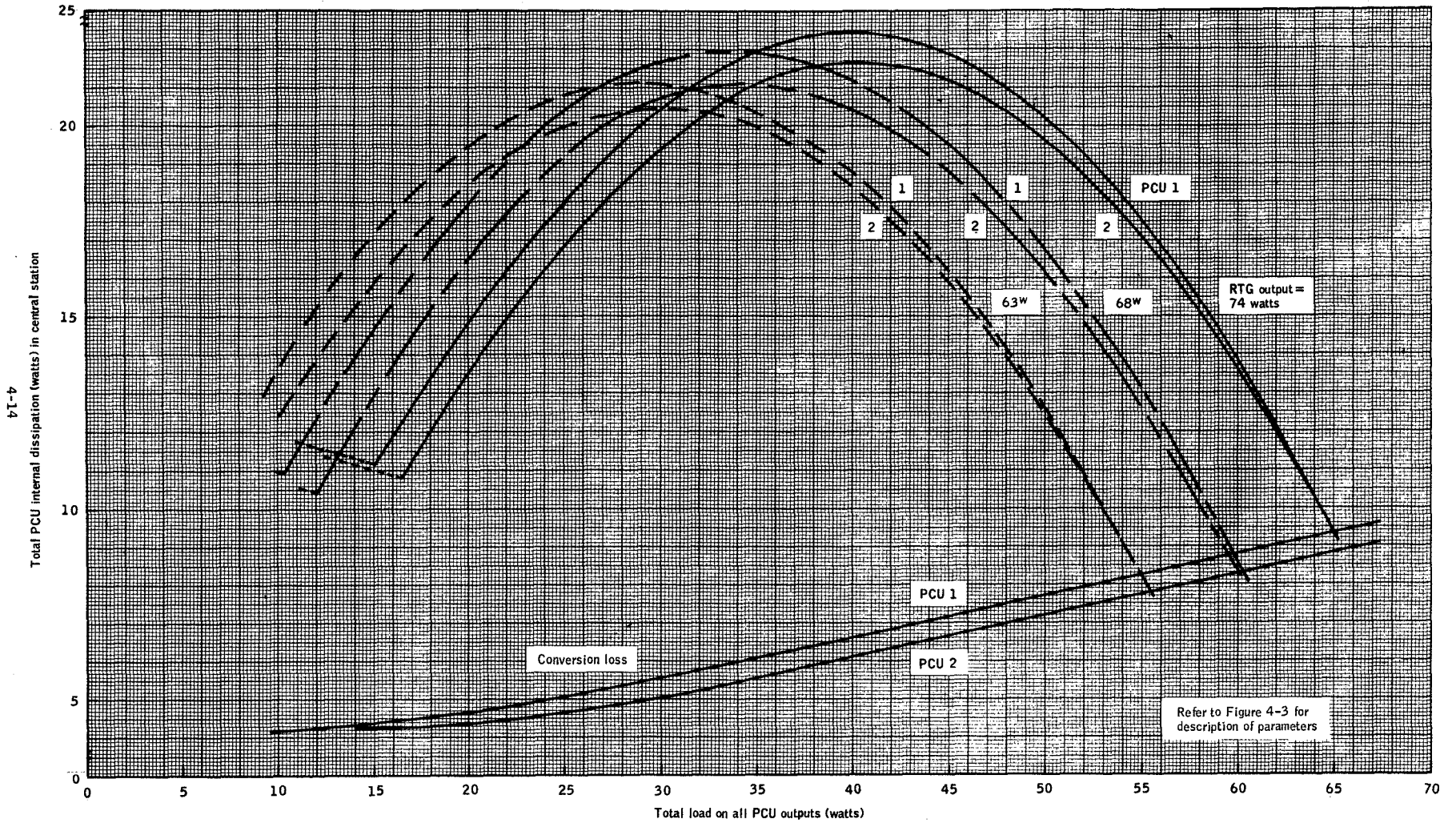

Figure 4-4. - PCU load vs RTG power output vs central station dissipation.

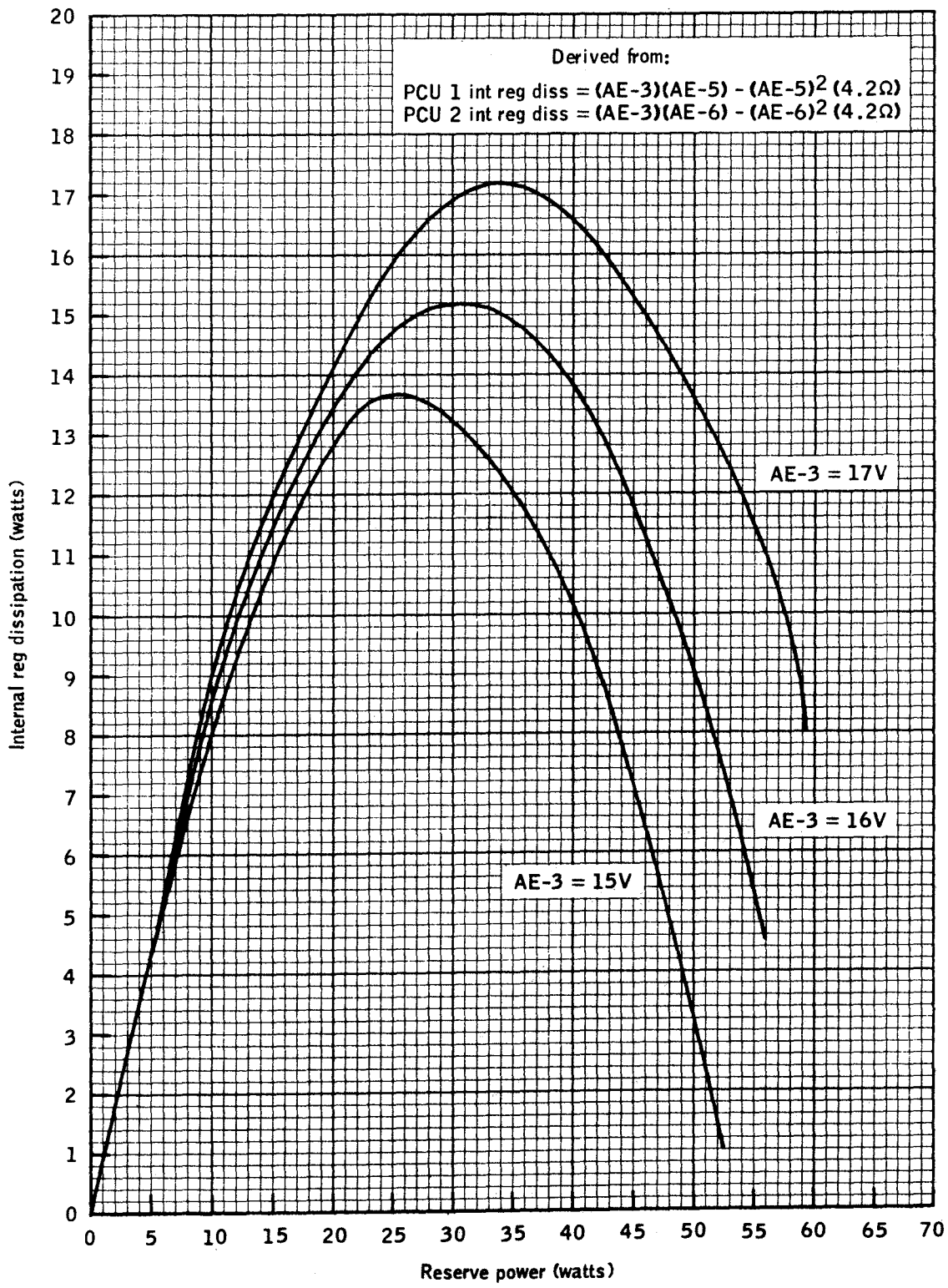

Figure 4-5. - Internal regulator dissipation.

TABLE 4-IV.- CIRCUIT BREAKER AND FUSE TABULATION

Number	Rating	Subsystem	Circuit	Effect
CB-02	110 to 225 mA	Transmitter A	+12 Vdc	Transmitter A does not utilize the +12 Vdc bus. Breaker CB-02 is self-resetting.
CB-03	560 to 840 mA	Transmitter A	+29 Vdc	Transmitter A +29 Vdc overload causes breaker CB-03 to switch transmitter B on. Breaker CB-03 is self-resetting.
CB-04	110 to 225 mA	Transmitter B	+12 Vdc	Transmitter B does not utilize the +12 Vdc bus. +12 Vdc is applied to the diplexer switch via CB-04 when transmitter B is selected. Breaker CB-04 is self-resetting.
CB-05	560 to 840 mA	Transmitter B	+29 Vdc	Transmitter B +29 Vdc overload causes breaker CB-05 to switch transmitter A on. Breaker CB-05 is self-resetting.
CB-06	450 to 550 mA	PSE operate	+29 Vdc	PSE instrument overload causes breaker CB-06 to place PSE in standby. Breaker CB-06 is self-resetting.
CB-07	450 to 550 mA	ASE (Exp 2)	+29 Vdc	ASE instrument overload causes breaker CB-07 to place ASE in standby. Breaker CB-07 is self-resetting.
CB-08	450 to 550 mA	LSM operate	+29 Vdc	LSM instrument overload causes breaker CB-08 to place LSM in standby. Breaker CB-08 is self-resetting.
CB-09	450 to 550 mA	HFE operate	+29 Vdc	HFE instrument overload causes breaker CB-09 to place HFE in standby. Breaker CB-09 is self-resetting.
CB-10	450 to 550 mA	DSS HTR 1	+29 Vdc	Overload causes breaker CB-10 to place DSS #2 in operate. Breaker CB-10 is self-resetting.
CB-11	450 to 550 mA	ASE (Exp 2)	+5 Vdc	Plus 5 Vdc from ALSEP applied to ASE only in OPER SEL. Circuit breaker located in ASE central station electronics. Cmd ASE to STBY TO RESET CB-11.
CB-12	135 to 165 mA	ASE (Exp 2)	+15 Vdc	Plus 15 Vdc from ALSEP applied to ASE only in OPER SEL. Circuit breaker located in ASE central station electronics. Cmd ASE to STBY to reset CB-12.
CB-13	135 to 165 mA	ASE (Exp 2)	-12 Vdc	Minus 12 Vdc from ALSEP applied to ASE only in OPER SEL. Circuit breaker located in ASE central station electronics. Cmd ASE to STBY to reset CB-13.
F-03	500 mA	PSE standby	+29 Vdc	A blown F-03 will permanently disable the PSE standby capability.
F-04	500 mA	ASE standby	+29 Vdc	A blown F-04 will permanently disable the ASE standby capability.
F-05	500 mA	LSM standby	+29 Vdc	A blown F-05 will only affect TM parameter AB-5. Refer to Drawing 4.2.
F-06	500 mA	HFE standby	+29 Vdc	A blown F-06 will permanently disable the HFE standby capability.
F-07	500 mA	DSS #2	+29 Vdc	A blown F-07 will permanently disable the DSS #2 heater capability.
F-08	1/32 A	Transmitter A	+29 Vdc	A blown F-08 will permanently disable all TM parameters from transmitter A.
F-09	1/32 A	Transmitter B	+29 Vdc	A blown F-09 will permanently disable all TM parameters from transmitter B.
F-10 F-11	125 mA 125 mA	Receiver A Receiver A	+12 Vdc +12 Vdc	F-10 & F-11 are paralleled to receiver A
F-12 F-13	125 mA 125 mA	Receiver B Receiver B	+12 Vdc +12 Vdc	F-12 & F-13 are paralleled to receiver B

TABLE 4-V. VOLTAGE DISTRIBUTION AND BUS LOAD ANALYSIS

NOTE

Experiment operational power is defined as maximum nighttime steady state (e.g., PSE oper). Experiment standby power is defined as maximum heater power (e.g., PSE stby). The voltage distribution and load analysis represent measurements at an ambient temperature of 70° F.

<u>Voltage bus</u>	<u>Circuit</u>	<u>Watts</u>	<u>Circuit protection^a</u>
+29 Vdc	PSE Oper	9.3	CB-06 500 mA ± 10%
	Stby	5.0	F-03 500 mA
	ASE Oper	5.5	CB-07 500 mA ± 10%
	Stby	3.1	F-04 500 mA
	LSM Oper	11.3	CB-08 500 mA ± 10%
	HFE Oper	9.8	CB-09 500 mA ± 10%
	Stby	4.2	F-06 500 mA
	DSS htr 1	10.0	CB-10 500 mA ± 10%
	Xmtr A	10.0 - 10.8 Avg.	CB-03 560 to 840 mA
	Xmtr B	10.0 - 10.8 Avg.	CB-05 560 to 840 mA
	Xmtr htr	8.4	None
	DSS htr 2	5.0	F-07 500 mA
	PDR 1	7.0	None
	PDR 2	14.0	None
	PDU	0.5	None
+15 Vdc	DSS/A	0.05	None
+12 Vdc	Cmd dec	0.325	None
	Timer	0.24	None
	Diplexer sw	0.1	CB-04 110 to 225 mA
	DSS/A	0.14	None
	DSS/D	0.05	None
	PCU	Negligible	None
	PDU	1.15	None
	Receiver	1.80	F-10 thru F-13
	Rcvr htr	1.25	None
Temp sensors	Negligible	None	
+5 Vdc	Cmd dec	0.775	None
	DSS/A	1.10	None
	DSS/D	0.450	None
	PDU	0.15	None
	Relay drivers	Negligible	None
-6 Vdc	Cmd dec	0.15	None
	PDU	Negligible	None
-12 Vdc	DSS/A	0.11	None
	PDU	0.6	None

^aRef Drawing 4.2.

TABLE 4-VI.- COMMANDS CAUSING DELTA POWER DEMANDS

Tabulation of ΔP caused by command execution assuming the following conditions exist:

The ALSEP subsystems will demand electrical power from the PCU in the following amounts:

Transmitter	Off		
DSS heater 1	Off		
PDR 2	Off		
DSS heater 2	Off		
PSE	Off		
LSM	Off		
ASE	Off		
HFE	Off		

		<u>Power (watts)</u>
Transmitter heater		8.40
Receiver		1.5
DSS/D		0.50
DSS/A		2.0
Cmd decoder		1.25
PDU		2.0
Timer		0.2
PCU conversion loss		<u>4.50</u>
Total		20.35

The 20.35 watts represents the minimum loading on the PCU. Add the delta power of any of the following commands to obtain total loading. PCU conversion losses increase with loading. For detailed experiment power demands, refer to experiment power profiles.

<u>Command</u>	<u>Delta power (watts)</u>	<u>Notes</u>
013 TRANSMITTER ON	2.4 2.5	Xmtr A selected by Cmd 012. Xmtr B selected by Cmd 015.
056 DSS HTR 2 ON	5.0	
022 PDR 2 ON	14.0	
055 DSS HEATER 1 ON	10.0	Thermostatically controlled.
036 EXP 1 OPER SEL (PSE)	4.3 9.3	Day scientific mode. Above +127° F. Night scientific mode. Below +125° F. (5-watt difference due to heater. See Cmd 076).
	11.6	Turn on transient.
037 EXP 1 STBY SEL (PSE)	5.0	Survival heaters.
042 EXP 2 OPER SEL (ASE)	7.0 4.0	3.0 W difference due to geophone AMP htr.
043 EXP 2 STBY SEL (ASE)	2.75 0.2	
045 EXP 3 OPER SEL (LSM)	5.5 10.5	Day scientific mode. Above +35° C. Night scientific mode. Below +35° C. (5-watt difference due to heaters. See Cmd 134.)
	10.2	Turn on transient.
046 EXP 3 STBY SEL (LSM)	0.0	No survival heaters in the LSM.
052 EXP 4 OPER SEL (HFE)	5.9 8.7	Day mode 1. Turn on transient.
053 EXP 4 STBY SEL	4.2	Survival heater.
055 DSS HTR 1	10 W	
056 DSS HTR 2	5 W	
070 LEVEL POWER X MOTOR (PSE)	3.0	Above PSE operate power (see Cmd 036). Exp 1 (PSE) must be operational.
071 LEVEL POWER Y MOTOR (PSE)		Same as Cmd 070.
072 LEVEL POWER Z MOTOR (PSE)		Same as Cmd 070.

TABLE 4-VI.- COMMANDS CAUSING DELTA POWER DEMANDS - Concluded

<u>Command</u>	<u>Delta power (watts)</u>	<u>Notes</u>
076 THERMAL CONTROL MODE (PSE)		
AUTO	0.04 to 5.7	Proportional heater (127° to 125° F). Heater on. Heater off. Exp 1 (PSE) must be operational.
FORCED	5.8	
OFF	0.0	
131 FLIP/CAL INITIATE (LSM)	3.4 (day) 1.0 (night)	Exp 2 (LSM) must be operational. Heaters switched off during flip-cal sequence. (1.0-watt above nominal night power demand of 10.9 watts.)
133 SITE SURVEY (LSM)	4.5	Day only. Exp 2 (LSM) must be operational.
134 TEMP CONTROL (LSM) X OR Y	5.0	Thermostatically controlled heaters. Heaters off. Exp 2 (LSM) must be operational.
OFF	0.0	

NOTE

PCU conversion loss (4.5-watt at minimum PCU loading) or shunt regulator dissipation not included. Conversion loss and shunt regulator dissipation dependent on PCU loading. Refer to Figures 4-4 and 4-5.

TABLE 4-VII.- CENTRAL STATION STEADY STATE POWER DEMANDS ON EACH VOLTAGE BUS FROM THE PCU

Subsystem	+29 Vdc	+15 Vdc	+12 Vdc	-12 Vdc	-6 Vdc	+5 Vdc	Total	Notes
Xmtr A DAY	11.9 W ^a							Cmd 012 selects A xmtr. Xmtr A protection: +29 Vdc CB-03. Cmd 015 selects B xmtr. Xmtr B protection: +29 Vdc CB-05.
Xmtr B DAY	11.9 W ^a		0.1 W					Cmd 013 turns on selected xmtr. Cmd 014 turns off selected xmtr. Overload on +29 Vdc bus (560 to 840 mA) causes a swith to other xmtr. When xmtr is commanded off (Cmd 014) xmtr heater is automatically turned on. The +12 Vdc bus is switched to diplexer when xmtr B is operational.
Xmtr Heater	8.4 W						8.4 W	
Receiver			0.79 W		0.03 W		0.82 W	No ground commands to control receiver. Overload on +12 Vdc bus (110 to 225 mA) disconnects +12 Vdc (via CB-01) from receiver and switches in receiver heater. Receiver is turned back on by 18-hour pulse from timer. -6 Vdc on continuously.
Receiver heater			1.25 W				1.25 W	
X or Y data processor			0.05 W			0.45 W	0.50 W	Cmd 034 selects X data proc, mux, and A/D converter.
X or Y analog mux & A/D conv		0.05 W	0.14 W	0.11 W		1.10 W	1.4 W	Cmd 035 selects Y data proc, mux, and A/D converter. No overload protection.
Command decoder			0.325 W		0.15 W	0.775 W	1.25 W	Command decoder is on continuously with no overload protection. Redundant decoders A and B addressable from ground.
PDU	0.5 W		1.15 W	0.6 W	0.008 W	0.15 W	2.4 W	PDU controls distribution of power to the ALSEP subsystems. +12, -12, and +5 Vdc are for power sequencer logic. +29 and +5 Vdc are used for relay drivers located in PDU.
DSS heater 1	10.0 W						10.0 W	Cmd 055 turns DSS 1 heater on. Cmd 056 turns DSS 1 heater off & DSS heater 2 on.
PCU 1 or PCU 2							4.5 to 8.5 W	Cmd 060 turns on PCU 1, PCU 2 off. Cmd 062 turns on PCU 2, PCU 1 off. Conversion loss is a function of loading on the PCU. See Figure 4-4.
DSS heater 2	5.0 W						5.0 W	Cmd 056 turns on DSS heater 2. Cmd 057 turns off DSS heater 2.
PDR 2	14.0 W						14.0 W	Cmd 022 turns on PDR 2. Cmd 023 turns off PDR 2. PDR 2 is located on the PDM and is exposed to the lunar environment. See Dwg 3.3.
DSS heater 3	10.0 W						10.0 W	Cmd 024 turns DSS heater 1 on. Cmd 025 turns DSS heater 1 off.

^aTransmitter power demand varies with temperature at AT-24 or AT-26.

TABLE 4-VIII.- RELAY DRIVER FUNCTIONS AND INPUT VOLTAGE REQUIREMENTS

Relay drivers	Relay	Function	Monitor	Cmd	+12 Vdc	Input voltage			+29 Vdc
						A	B	C	
RD-01	K-01	PCU 1 SEL	AE-5	060	X				
02	K-01	PCU 2 SEL	AE-6	062	X				
03	K-06	EXP 1 OPER SEL	*	036			X		X
04	K-06	EXP 1 STBY SEL	AB-4	037			X	X	
05	K-07	EXP 1 STBY SEL	AB-4	037			X	X	
06	K-07	EXP 1 STBY OFF	*	041			X	X	
07	K-08	EXP 2 OPER SEL	*	042			X		X
08	K-08	EXP 2 STBY SEL	AB-4	043			X	X	
09	K-09	EXP 2 STBY SEL	AB-4	043			X	X	
10	K-09	EXP 2 STBY OFF	*	044			X	X	
11	K-10	EXP 3 OPER SEL	*	045			X		X
12	K-10	EXP 3 STBY SEL	AB-5	046			X	X	
13	K-11	EXP 3 STBY SEL	AB-5	046			X	X	
14	K-11	EXP 3 STBY OFF	*	050			X	X	
15	K-12	EXP 4 OPER SEL	*	052			X		X
16	K-12	EXP 4 STBY SEL	AB-5	053			X	X	
17	K-13	EXP 4 STBY SEL	AB-5	053			X	X	
18	K-13	EXP 4 STBY OFF	*	054			X	X	
19	K-14	DSS HTR 1 CNTL	*	055			X		X
20	K-14	DSS HTR 1 CNTL	AB-5	056			X	X	
21	K-15	DSS HTR 1 CNTL	AB-5	056			X	X	
22	K-15	DSS HTR 1 CNTL	*	057			X	X	
23									
24	K-02	DSS/PROC Y SEL	AB-6	035				X	X
25	K-03	DSS/PROC X SEL	AB-6	034				X	X
26	K-04	XMTR OFF		014		X			X
27	K-04	XMTR ON		013		X			X
28	K-05	XMTR A SEL	AE-17	012			X	X	
29	K-05	XMTR B SEL	AE-18	015			X	X	
30	K-18	DSS HTR 3 ON	*	024		X			X
31	K-18	DSS HTR 3 OFF	*	025		X			X
32	K-16	DISSIP R1 ON	*	017		X			X
33	K-16	DISSIP R1 OFF	*	021		X			X
34	K-17	DISSIP R2 ON	*	022		X			X
35	K-17	DISSIP R2 OFF	*	023		X			X

*Function determined by monitoring PCU 1 shunt current AE-5, or PCU 2 shunt current AE-6.

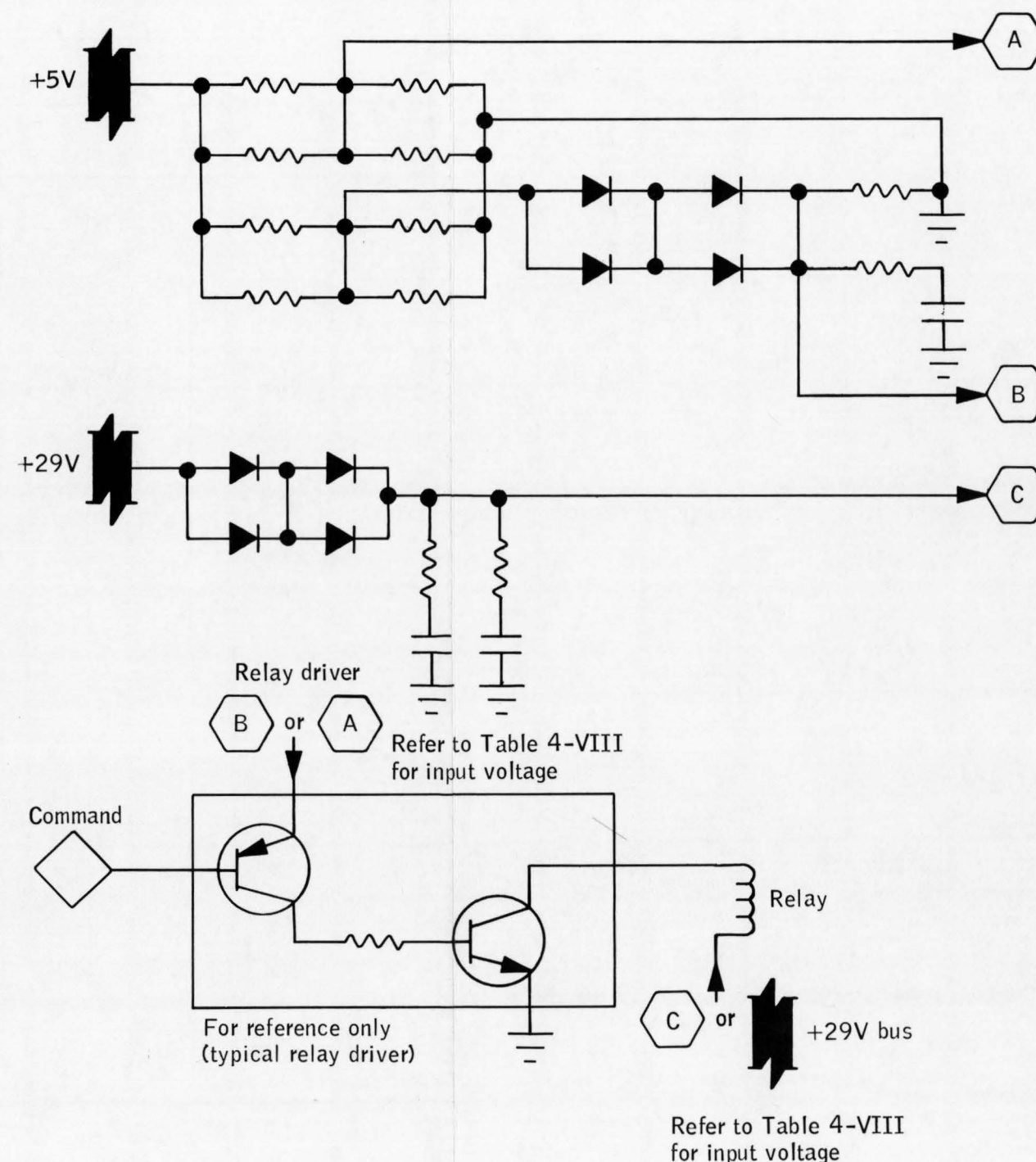
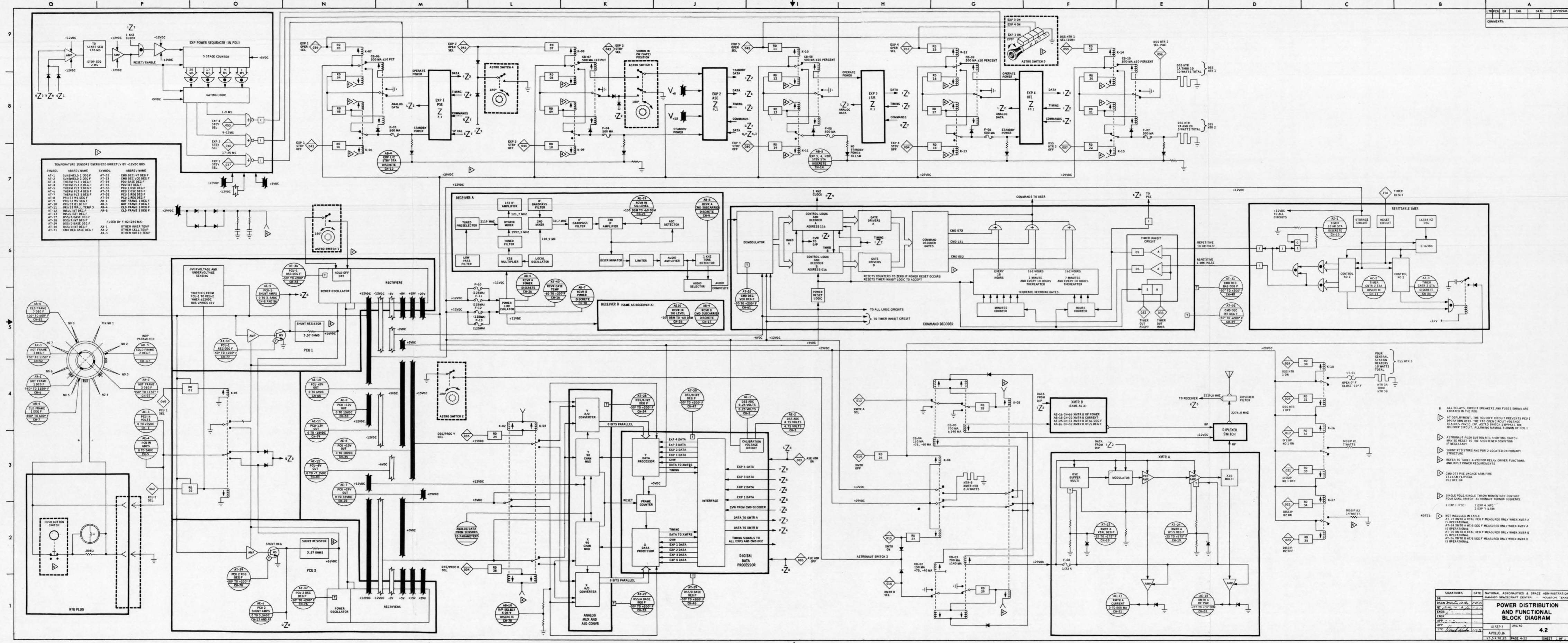

Figure 4-6. - Relay driver voltages.



TEMPERATURE SENSORS ENERGIZED DIRECTLY BY +12VDC BUS

SYMBOL	ABBREV NAME	SYMBOL	ABBREV NAME
AT-1	SUNSHIELD 1 DEG F	AT-32	CMD DEC INT DEG F
AT-2	SUNSHIELD 2 DEG F	AT-33	CMD DEC VDD DEG F
AT-3	THERM PNT 1 DEG F	AT-34	PCU BASE DEG F
AT-4	THERM PNT 2 DEG F	AT-35	PCU INT DEG F
AT-5	THERM PNT 3 DEG F	AT-36	PCU 1 DEG DEG F
AT-6	THERM PNT 4 DEG F	AT-37	PCU 2 DEG DEG F
AT-7	THERM PNT 5 DEG F	AT-38	PCU 3 DEG DEG F
AT-8	PRV/ST 1 DEG F	AT-39	PCU 4 DEG DEG F
AT-9	PRV/ST 2 DEG F	AT-40	PCU 5 DEG DEG F
AT-10	PRV/ST 3 DEG F	AT-41	PCU 6 DEG DEG F
AT-11	PRV/ST 4 DEG F	AT-42	PCU 7 DEG DEG F
AT-12	PRV/ST 5 DEG F	AT-43	PCU 8 DEG DEG F
AT-13	PRV/ST 6 DEG F	AT-44	PCU 9 DEG DEG F
AT-14	PRV/ST 7 DEG F	AT-45	PCU 10 DEG DEG F
AT-15	PRV/ST 8 DEG F	AT-46	PCU 11 DEG DEG F
AT-16	PRV/ST 9 DEG F	AT-47	PCU 12 DEG DEG F
AT-17	PRV/ST 10 DEG F	AT-48	PCU 13 DEG DEG F
AT-18	PRV/ST 11 DEG F	AT-49	PCU 14 DEG DEG F
AT-19	PRV/ST 12 DEG F	AT-50	PCU 15 DEG DEG F
AT-20	PRV/ST 13 DEG F	AT-51	PCU 16 DEG DEG F
AT-21	PRV/ST 14 DEG F	AT-52	PCU 17 DEG DEG F
AT-22	PRV/ST 15 DEG F	AT-53	PCU 18 DEG DEG F
AT-23	PRV/ST 16 DEG F	AT-54	PCU 19 DEG DEG F
AT-24	PRV/ST 17 DEG F	AT-55	PCU 20 DEG DEG F
AT-25	PRV/ST 18 DEG F	AT-56	PCU 21 DEG DEG F
AT-26	PRV/ST 19 DEG F	AT-57	PCU 22 DEG DEG F
AT-27	PRV/ST 20 DEG F	AT-58	PCU 23 DEG DEG F
AT-28	PRV/ST 21 DEG F	AT-59	PCU 24 DEG DEG F
AT-29	PRV/ST 22 DEG F	AT-60	PCU 25 DEG DEG F
AT-30	PRV/ST 23 DEG F	AT-61	PCU 26 DEG DEG F
AT-31	PRV/ST 24 DEG F	AT-62	PCU 27 DEG DEG F

USED BY F-02 (250 MA)
 AX-1 DTRM INNER TEMP
 AX-2 DTRM CELL TEMP
 AX-3 DTRM OUTER TEMP

- ▶ ALL RELAYS, CIRCUIT BREAKERS AND FUSES SHOWN ARE LOCATED IN THE PDU
- ▶ AT DEVELOPMENT, THE HOLD OFF CIRCUIT PREVENTS PCU 1 OPERATION UNTIL THE HOLD OFF CIRCUIT VOLTAGE REACHES 5VDC. SW. ASTRO SWITCH 1 PASSES THE HOLD OFF CIRCUIT, ALLOWING MANUAL TURN ON OF PCU 1 IF NECESSARY
- ▶ ASTRONAUT PUSH BUTTON (R/L) SHORTING SWITCH MAY BE RESET TO THE SHORTED CONDITION IF NECESSARY
- ▶ REFER TO TABLE 4-10 FOR RELAY DRIVER FUNCTIONS AND INPUT POWER REQUIREMENTS
- ▶ CMD 073 PSE UNCAUSE ARM/FIRE 1.1 LHM FLTP/CA 0.52 MFE ON
- ▶ SINGLE POLE/SINGLE THROW MOMENTARY CONTACT FOUR GANG SWITCH, ASTRONAUT TURN ON SEQUENCE 1 EXP 3 (PSE) 2 EXP 4 (MFC) 3 EXP 1 (LSM)
- ▶ NOT INCLUDED IN TABLE
- ▶ AT-23 BATTER 8.55 DEG F MEASURED ONLY WHEN XMTA IS OPERATIONAL
- ▶ AT-24 BATTER 8.55 DEG F MEASURED ONLY WHEN XMTB IS OPERATIONAL
- ▶ AT-25 BATTER 8.55 DEG F MEASURED ONLY WHEN XMTA IS OPERATIONAL
- ▶ AT-26 BATTER 8.55 DEG F MEASURED ONLY WHEN XMTB IS OPERATIONAL
- ▶ AT-27 BATTER 8.55 DEG F MEASURED ONLY WHEN XMTA IS OPERATIONAL
- ▶ AT-28 BATTER 8.55 DEG F MEASURED ONLY WHEN XMTB IS OPERATIONAL

5 COMMAND
SUBSYSTEM

*

5.1 COMMAND RECEIVER FUNCTIONAL DESCRIPTION

Functionally, the command receiver is comprised of two redundant receivers which share common interface/control circuits. The 2119 MHz phase modulated carrier uplink signal is received by the central station antenna, coupled through the diplexer, and applied to the command receiver RF coupler. The coupler is a stripline hybrid which applies the uplink signal to both receiver sections.

The uplink signal is passed through a low-pass filter, coupled through a tuned 3-pole pre-selector, and applied to the first mixer. The first mixer is a stripline hybrid which mixes the uplink signal with a 1997.3 MHz crystal-controlled local oscillator signal to produce a 121.7 MHz first IF signal. The IF signal is amplified and applied through a 3-stage IF bandpass filter to the second mixer. The second mixer is an integrated circuit which mixes the 121.7 MHz first IF signal with a 110.9 MHz crystal-controlled local oscillator signal to produce a 10.7 MHz second IF signal.

The 110.9 MHz local oscillator/amplifier output is increased in frequency to 1997.3 MHz by a multiply-by-18 frequency multiplier, and coupled through a 2-pole tuned filter to the first mixer to develop the first IF. The local oscillator output is applied directly to the second mixer to develop the second IF.

The second IF signal is applied through a 5-stage IF bandpass filter to the second IF amplifier. The amplifier output is sampled by the AGC detector to develop the AGC feedback voltage. This voltage is also applied to the interface as a signal level telemetry signal to provide engineering data regarding the received signal carrier level. The amplifier output is applied to the first discriminator where it is demodulated. The composite 2 KHz data subcarrier and 1 KHz synchronization sub-carrier signal is applied through the limiter and the final audio amplifier to the audio selector for output.

The audio amplifier output is sampled by the 1 KHz tone detector to develop a command signal present voltage. The receiver A signal is applied to the audio selector as a control signal, and is output as a telemetry signal. The receiver B signal is output directly as a telemetry signal.

The audio selector receives the audio outputs from both receiver sections A and B, and applies one of these audio signals to the command decoder. The selected audio output is from receiver section A when the "command signal present A" signal is present. The absence of this signal causes the audio output from receiver section B to be selected.

The power line isolator provides redundant series regulator circuits, each of which receives +12 Vdc from the PDU, and supplies +11 Vdc operating power to its corresponding receiver section. Each operating power line is monitored for engineering data. The temperature of the receiver case is monitored by a thermistor for engineering data. The engineering data measurements are supplied to the multiplexer/converter.

5.2 COMMAND FUNCTIONS

003 ASE HBR ON DATA PROCESSOR

Command 003 disconnects the data processor from the modulator and connects the modulator to the active seismic processor which supplies the high-bit-rate data (10,600 bps). The ASE HBR ON command takes effect at the scheduled end of the 64-word data-processor frame which is in progress at the time the mode change command is received. The downlink data are meaningless if this command is executed with no ASE in the flight configuration.

005 ASE HBR OFF DATA PROCESSOR

Command 005 disconnects the ASE processor from the modulator and connects the modulator to the data processor which supplies data at 530 or 1060 bps, depending on the last bit-rate mode commanded. The ASE HBR OFF command takes effect at the scheduled end of the 64-word data processor frame which is in progress at the time the mode change command is received. Central station activation or power reset initializes ASE HBR to OFF.

006 NORM BIT RT SEL DATA PROCESSOR

Command 006 causes the data processor to operate at the normal bit rate (1060 bps). This command takes effect at the scheduled end of the 64-word frame which is in progress at the time the mode change command is received. Central station activation or power reset initializes the data processor to NORMAL BIT RATE.

007 LOW BIT RT SEL DATA PROCESSOR

Command 007 causes the data processor to operate at low bit rate (530 bps). This command takes effect at the scheduled end of the 64-word frame which is in progress at the time the mode change command is received.

NOTE

EXP 3 (LSM) data are meaningless
on LOW BIT RATE

011 NORM BIT RT RST DATA PROCESSOR

Command 011 is a provision for returning the operational data processor (determined by Command 034 or 035) to the normal bit rate from either the high or low bit rate. This command does not reset the analog multiplexer or frame counter.

This command takes effect immediately and does not wait until the scheduled end of the 64-word frame.

NOTE

Commands that switch bit rates, transmitters, or data processors are commands which will cause a loss of sync at the ground station and a loss or false readout of command verification word.

- 012 XMTR A SEL POWER DISTRIBUTION UNIT
Command 012 actuates relay K-05, in the PDU, to the position that selects transmitter A. XMTR A SEL is the lunar surface initial condition.
- 013 XMTR ON POWER DISTRIBUTION UNIT
Command 013 actuates relay K-04, in the PDU, which applies +29 Vdc to the transmitter selected by Command 012 or 015. This command simultaneously removes +29 Vdc from the 8.4-watt transmitter heater located on the thermal plate. XMTR ON is the lunar surface initial condition.
- 014 XMTR OFF POWER DISTRIBUTION UNIT
Command 014 actuates relay K-04, in the PDU, to the position that removes +29 Vdc from the transmitter selected by Command 012 or 015. This command simultaneously applies +29 Vdc to the 8.4-watt transmitter heater.
- 015 XMTR B SEL POWER DISTRIBUTION UNIT
Command 015 actuates relay K-05, in the PDU, to the position that selects Transmitter B.
- 017 DISSIP R1 ON POWER DISTRIBUTION UNIT
Command 017 actuates relay K-16, in the PDU, to the position that applies +29 Vdc to a 7-watt power dump resistor and is used to optimize the load on the PDU.

- 021 DISSIP R1 OFF POWER DISTRIBUTION UNIT
Command 021 actuates relay K-16, in the PDU, to the position that removes +29 Vdc from the 7-watt power dump resistor.
- 022 DISSIP R2 ON POWER DISTRIBUTION UNIT
Command 022 actuates relay K-17, in the PDU, to the position that applies +29 Vdc to a 14-watt power dump resistor and is used to optimize the load on the PCU.
- 023 DISSIP R2 OFF POWER DISTRIBUTION UNIT
Command 023 actuates relay K-17, in the PDU, to the position that removes +29 Vdc from the 14-watt power dump resistor.
- 024 DSS HTR 3 ON POWER DISTRIBUTION UNIT
Command 024 actuates relay K-18, in the PDU, to the position that applies +29 Vdc to the thermostatically controlled 10-watt heater located on the central station thermal plate. This heater is controlled by thermostat ST-01 to ON below -10° F and OFF above 0° F. This thermal capability for the central station is provided to account for unknown factors in the lunar environment. DSS HTR 3 ON is the lunar surface initial condition.
- 025 DSS HTR 3 OFF POWER DISTRIBUTION UNIT
Command 025 actuates relay K-18, in the PDU, to the position that removes the +29 Vdc from the thermostatically controlled 10-watt central station heater.
- 032 TIMER OUTPUT ACCPT COMMAND DECODER
Command 032 enables the 18-hour and the 1-minute timer output pulses, thus allowing automatic commands to be generated by the timer and the delayed command sequencer. This command cancels the effect of command 033. Central station activation or power reset initializes the time output ACCPT.

033 TIMER OUTPUT INHIB COMMAND DECODER

Command 033 inhibits the 18-hour and the 1-minute timer output pulses which in turn will disable the following automatic commands generated in the delayed-command sequencer.

<u>One-Time Command</u>	<u>Normal Time of Execution After Command Sequencer Reset</u>
ARM PSE UNCAGE CIRCUIT	Eight 18-hour pulses +2 Min and every 18 hours thereafter.

Repetitive Commands

MAGNETOMETER FLIP
CALIBRATE Nine 18-hr pulses +1 Min and every
18 hours thereafter.

EXP 4 OPERATE SEL (HFE) Nine 18-hr pulses +7 Min and every
18 hours thereafter.

Command 033 will also disable the following automatic commands generated by the timer. These are repetitive (every 18-hour pulse commands):

- A. Short Period Calibrate PSE
- B. UNCAGE PSE
 - 1. ARM UNCAGE PSE (First 18-hour pulse)
 - 2. EXECUTE UNCAGE PSE (Second 18-hour pulse)

NOTE

This command will input level changes to the hour and minute counters of the delayed-command sequencer and advance the counters by 18 hours and 1 minute. This may change the execution times of the automatic commands from the delayed-command sequencer and the timer. This command does not inhibit or affect the 3-month transmitter turn off command generated by the timer.

034 DSS/PROC X SEL POWER DISTRIBUTION UNIT

Command 034 actuates relays K-02 and K-03, in the PDU,

that apply operational voltages (+15 Vdc, +5 Vdc, -12 Vdc) to the "X" data processor. It simultaneously removes the above voltages from the "Y" processor. The "X" data processor, upon activation, is initialized to the normal bit rate. DSS/PROC X SEL is the lunar surface initial condition.

NOTE

This command may result in sync loss at ground station, hence possible loss or false readout of command verification word.

035 DSS/PROC Y SEL POWER DISTRIBUTION UNIT

Command 035 actuates relays K-02 and K-03, in the PDU, that apply operational voltages (+15 Vdc, +5 Vdc, -12 Vdc) to "Y" data processor. It simultaneously removes the above voltages from the "X" processor. The "Y" data processor, upon activation, is initialized to the normal bit rate.

NOTE

This command may result in sync loss at ground station, hence possible loss or false readout of command verification word.

036 EXP 1 OPER SEL (PSE) POWER DISTRIBUTION UNIT

Command 036 actuates relay K-06, in the PDU, applying +29 Vdc to the PSE instrument and the heater circuitry in the deployed PSE sensor assembly. It simultaneously removes +29 Vdc from the standby heater in the PSE electronics package in the central station.

037 EXP 1 STBY SEL (PSE) POWER DISTRIBUTION UNIT

Command 037 actuates relays K-06 and K-07, in the PDU, applying +29 Vdc to the standby heater in the PSE electronics package and to the heater in the deployed PSE sensor assembly. It simultaneously deactivates the PSE by removing +29 Vdc

from the instrument. EXP 1 STBY SEL (PSE) is the lunar surface initial condition.

041 EXP 1 STBY OFF (PSE) POWER DISTRIBUTION UNIT

Command 041 actuates relay K-07, in the PDU, to the position that removes +29 Vdc from both PSE heater circuits. If the operating power is on, transmission of this command will have no effect.

042 EXP 2 OPER SEL (ASE) POWER DISTRIBUTION UNIT

Command 042 activates relay K-08, in the PDU, applying +29 Vdc to one terminal of Astro Switch No. 5. With Astro Switch No. 5 in a CCW position, the 29 Vdc operating voltage will be applied to the ASE, which in turn, will cause the ALSEP +5 Vdc, +15 Vdc, and -12 Vdc supply voltages to be switched to the ASE electronics. This function places all operating voltages on the ASE and simultaneously deactivates the ASE standby heater. Note that the ASE uses ALSEP supply voltages and has no internal power converter.

043 EXP 2 STBY SEL (ASE) POWER DISTRIBUTION UNIT

Command 043 activates relays K-08 and K-09, in the PDU, applying standby +29 Vdc to the ASE heater and simultaneously removing +29 Vdc, +5 Vdc, +15 Vdc, and -12 Vdc operating voltages from the ASE. EXP 2 STBY SEL is the lunar surface initial condition. Note that Exp 2 (ASE) is not included in the automatic power sequencing. Cmd 043 resets the +5 Vdc, +12 Vdc, and -12 Vdc circuit breakers in the ASE.

044 EXP 2 STBY OFF (ASE) POWER DISTRIBUTION UNIT

Command 044 actuates relay K-09, in the PDU, to the position that removes +29 Vdc from the ASE standby heater. If the ASE is in operate mode, transmission of this command will have no effect.

- 045 EXP 3 OPER SEL (LSM) POWER DISTRIBUTION UNIT
Command 045 actuates relay K-10, in the PDU, applying +29 Vdc to activate the LSM.
- 046 EXP 3 STBY SEL (LSM) POWER DISTRIBUTION UNIT
Command 046 actuates relays K-10 and K-11, in the PDU, to the position that deactivates the LSM instrument but does not apply standby power. EXP 3 STBY SEL (LSM) is the lunar surface initial condition.
- 050 EXP 3 STBY OFF (LSM) POWER DISTRIBUTION UNIT
Command 050 actuates relay K-11, in the PDU, to the position that removes +29 Vdc from the resistive summing network to TM parameter AB-5. The LSM uses no standby power. If the LSM operating power is on, transmission of this command will have no effect.
- 052 EXP 4 OPER SEL (HFE) POWER DISTRIBUTION UNIT
Command 052 actuates relay K-12, in the PDU, applying +29 Vdc to the HFE instrument and the heater circuitry in the deployed HFE electronics assembly. It simultaneously removes +29 Vdc from the standby heater in the HFE electronics package.
- 053 EXP 4 STBY SEL (HFE) POWER DISTRIBUTION UNIT
Command 053 actuates relays K-12 and K-13, in the PDU, applying +29 Vdc to the standby heater in the HFE electronics package. It simultaneously deactivates the HFE by removing +29 Vdc from the instrument. EXP 4 STBY SEL is the lunar surface initial condition.
- 054 EXP 4 STBY OFF (HFE) POWER DISTRIBUTION UNIT
Command 054 actuates relay K-13, in the PDU, to the position that removes +29 Vdc from the HFE heater circuit. If the HFE operating power is on, transmission of this command will have no effect.

ALSEP 3
BASIC

- 055 DSS HTR 1 SEL POWER DISTRIBUTION UNIT
Command 055 actuates relay K-14, in the PDU, to the position that applies +29 Vdc to the 10-watt DSS HTR 1.
- 056 DSS HTR 2 SEL POWER DISTRIBUTION UNIT
Command 056 actuates relays K-14 and K-15, in the PDU, to the position that applies +29 Vdc to the 5-watt DSS HTR 2 and simultaneously removes +29 Vdc from DSS HTR 1.
- 057 DSS HTR 2 OFF
Command 057 actuates relay K-15, in the PDU, to the position that removes +29 Vdc from the 5-watt DSS HTR 2. If DSS HTR 1 is ON, this command will have no effect. Initially, DSS HTR 1 and 2 will be OFF.
- 060 PCU 1 SEL POWER CONDITIONING UNIT
Command 060 actuates relay K-01, in the PCU, which applies +16 Vdc from the RTG to PCU 1 and simultaneously de-energizes PCU 2. PCU 1 is preset to be energized at initial lunar activation. Note that there is an automatic switchover feature to PCU 2 in the event the +12 Vdc bus varies more than +1 Vdc. Adding or removing electrical loads (via ground commands) on PCU 1 can prevent the +12 Vdc bus from varying out of limits.

NOTE

IN THE EVENT AUTOMATIC SWITCHOVER TO PCU 2 HAS OCCURRED, THIS COMMAND MUST BE FLAGGED AS HIGHLY CRITICAL. THE CAUSE OF THE SWITCHOVER MUST BE DETERMINED BEFORE THIS COMMAND IS EXECUTED.

SWITCHOVER FROM PCU 1 TO PCU 2 MAY GENERATE A POWER RESET SIGNAL TO THE DELAYED COMMAND SEQUENCER COUNTERS, RESETTING THE COUNTERS BACK TO ZERO. PCU SWITCHING WILL CAUSE SYNC LOSS AT GROUND STATION.

062 PCU 2 SEL POWER CONDITIONING UNIT

Command 062 actuates relay K-01, in the PCU, which applies +16 Vdc from the RTG to PCU 2 and simultaneously de-energizes PCU 1.

NOTE

AT THE TIME OF LUNAR ACTIVATION PCU 2 IS DE-ENERGIZED, WITH NO MEANS TO DETERMINE ITS CONDITION. FURTHER, NOTE THAT THERE IS NO AUTOMATIC SWITCHOVER FROM PCU 2 TO PCU 1. THIS SITUATION, THEREFORE, MAKES THIS COMMAND HIGHLY CRITICAL. THIS COMMAND SHOULD BE EXECUTED ONLY AFTER DETERMINING THAT PCU 1 IS ON THE VERGE OF FAILING:

SWITCHOVER FROM PCU 2 TO PCU 1 MAY GENERATE A POWER RESET SIGNAL TO THE DELAYED COMMAND SEQUENCER COUNTERS, RESETTING THE COUNTERS BACK TO ZERO. PCU SWITCHING WILL CAUSE SYNC LOSS AT GROUND STATION.

063 PSE/XY GAIN CH EXP 1 (PSE)

Command 063 switches different attenuator values into the LPX and LPY amplifier circuits to allow gain control of the long period X- and Y-axis signals. Repeated transmission of the command will cause the attenuators to step through values of 0 db, -10 db, -20 db, and -30 db in a repeating sequence. In addition, this command controls the calibration current of these two axes. PSE activation initializes the attenuators to -30 db.

064 PSE/Z GAIN CH EXP 1 (PSE)

Command 064 switches different attenuator values into the LPZ amplifier circuit to allow gain control of the long period Z-axis signal. Repeated transmission of the command will cause the attenuator to step through values of 0 db, -10 db, -20 db, and -30 db in a repeating sequence. In

addition, this command controls the calibration current of this axis. PSE activation initializes the attenuator to -30 db.

065 PSE/SP CAL CH EXP 1 (PSE)

Command 065 activates logic that will apply a current, via the SP calibration attenuator, to the SP calibration coil. The amount of current from the calibration attenuator is determined by Command 067. In addition, the SP calibration is automatically performed every 12 hours by means of the timer unless specifically inhibited by Command 033. This is a sequential ON/OFF command. PSE activation initializes SP calibration to OFF.

066 PSE/LP CAL CH EXP 1 (PSE)

Command 066 activates logic that applies current, via the LP calibration attenuators, to the LP damping coils (all three axes simultaneously). The amount of current from the calibration attenuators is determined by Command 063 and Command 064. This is a sequential ON/OFF command. PSE activation initializes LP calibration to OFF.

067 PSE/SP GAIN CH EXP 1 (PSE)

Command 067 switches different attenuator values into the SPZ amplifier circuit to allow gain control of the SP axis signal. Repeated transmission of the command will cause the attenuator to step through values of 0 db, -10 db, -20 db, and -30 db in a repeating sequence. In addition, this command controls the calibration current of this axis. PSE activation initializes the attenuator to -30 db.

070 LVL MTRX ON/OFF EXP 1 (PSE)

Command 070 activates logic which applies power to the X-axis drive motor. This is a sequential ON/OFF command.

PSE activation initializes X motor to OFF. Note that the X motor consumes power in either leveling mode (AUTOMATIC/FORCED) until commanded OFF.

NOTE

Do not turn on more than one leveling motor at a time. De-energize sensor heater via Command 076 during time any level motor is on.

071 LVL MTRY ON/OFF EXP 1 (PSE)

Command 071 activates logic which applies power to the Y-axis drive motor. This is a sequential ON/OFF command. PSE activation initializes Y motor to OFF. Note that the Y motor consumes power in either leveling mode (AUTOMATIC/FORCED) until commanded OFF.

NOTE

Do not turn on more than one leveling motor at a time. De-energize sensor heater via Command 076 during time any level motor is on.

072 LVL MTRZ ON/OFF EXP 1 (PSE)

Command 072 activates logic which applies power to the Z-axis drive motor. This is a sequential ON/OFF command. PSE activation initializes Z motor to OFF. Note that the Z motor consumes power in either leveling mode (AUTOMATIC/FORCED) until commanded OFF.

NOTE

DO NOT TURN ON Z LEVELING MOTOR WHILE PSE IS CAGED. Do not turn on more than one leveling motor at a time. De-energize sensor heater via command 076 during time any level motor is on.

073 UNCAGE ARM/FIRE EXP 1 (PSE)

- A. Command 073 is a two-state command (ARM/FIRE). First transmission will arm the actuator circuit. Second transmission of this command is sent to fire the actuator circuit and uncage all spring mass systems simultaneously. This command is an irreversible function and is necessary to obtain PSE scientific data.
- B. The ARM and FIRE commands are also automatically generated by the timer every 18 and 36 hours, respectively, after PET-zero.
- C. Conditions to ARM:
 - 1. First transmission of Command 073.
 - 2. First 12-hour timer pulse.
 - 3. 144 hours + 2 minutes pulse from the delayed command sequencer.
- D. Conditions to FIRE (after ARM, above):
 - 1. Next transmission of Command 073.
 - 2. Next 18-hour timer pulse.
 - 3. If armed, placing PSE to standby (Command 037 or operational overload).

NOTE

THE UNCAGE CIRCUITRY WILL NOT
FUNCTION BELOW 30° F.

074 LVL DIR POS/NEG EXP 1 (PSE)

Command 074 is a two-state command (POS/NEG) which controls the direction of the level motors for LPX, LPY, and LPZ axes when in the forced leveling mode (see Command 103). PSE activation initializes leveling direction to POS.

075 LVL SPEED HI/LO EXP 1 (PSE)

Command 075 is a two-state command (HI/LO) which controls the speed of the leveling motors for LPX, LPY, and LPZ axes when in the forced leveling mode (see Command 103). PSE activation initializes leveling speed to LO.

076 PSE T CTL CH EXP 1 (PSE)

Command 076 is a four-state command that can be sequentially stepped through the following modes to control the heater in the deployed PSE sensor.

- A. OFF - +29 Vdc is disconnected from the heater.
- B. FORCED - +29 Vdc applied to heater and automatic thermostat control disabled.
- C. OFF - +29 Vdc is disconnected from the heater.
- D. AUTOMATIC - +29 Vdc applied to heater and automatic thermostat control enabled.

PSE activation initializes thermal control mode to AUTOMATIC. Note that this command does not control the heater in the PSE electronics package in the central station. Note that the PSE sensor heater is not controlled by this command when the experiment is in EXP 1 STBY SEL.

101 PSE FILT IN/OUT EXP 1 (PSE)

Command 101 is a two-state command (IN/OUT) which effectively removes the feedback loop filters from the LPX, LPY, and LPZ axes. PSE activation initializes the feedback filter to OUT.

The feedback filter has to be in the following modes for the PSE to operate properly:

- A. Leveling (all modes) - filter OUT
- B. Calibration - filter IN
- C. Normal operational mode - filter IN

102 LVL SNSR IN/OUT EXP 1 (PSE)

Command 102 is a two-state command (IN/OUT) which activates logic that enables the coarse level sensors to control the LPX and LPY axes drive motors when an off level condition exists. The coarse level sensors are used only in the automatic leveling mode. PSE activation initializes the coarse level sensor to OUT.

103 PSE LVL MDE A/F EXP 1 (PSE)

Command 103 is a two-state command (AUTOMATIC/FORCED) which controls the leveling mode of LPX, LPY, and LPZ axes. PSE activation initializes the leveling mode to AUTOMATIC.

NOTE

Only one axis motor is to be on
at a time.

123 LSM RANGE STEPS EXP 3 (LSM)

Command 123 is a three-state command that determines the range of the X-, Y-, and Z-axes sensors of the LSM. LSM activation initializes the range to ± 200 gamma. Repeated application of this command sequences the range through ± 50 , ± 100 , ± 200 gamma. The selected range is common to all three sensors.

124 LSM FLD O/S CH EXP 3 (LSM)

Command 124 is a seven-state command that controls field offset of the X-, Y-, and Z-axes. LSM activation initializes the offset to 0 percent. Repeated application of this command sequences the offset through +25, +50, +75, -75, -50, -25, and 0 percent of the range selected by Command 123. Example: With Command 123 set to ± 100 gamma and Command 124 set to +25 percent, the effective range of the addressed sensor would be +125 to -75 gamma (sensor heads in 0° or 90° position).

125 LSM O/S ADD CH EXP 3 (LSM)

Command 125 is a four-state command used to address the X-, Y-, and Z-axes for offsetting. LSM activation initializes the offset address to neutral. Neutral is defined as no axis addressed. Repeated application of this command sequences the offset address from X to Y to Z to neutral. Example: With this command set to the X-axis, Command 124 controls the offset of the X-axis only, with Y- and Z-axes unaffected.

127 FLIP/CAL INHIB EXP 3 (LSM)

Command 127 is a two-state command (IN/OUT) used to inhibit the flip/calibrate sequence of the LSM. LSM activation initializes the logic to inhibit IN.

NOTE

SINCE THIS COMMAND WILL INHIBIT THE FLIP/CAL COMMAND FROM THE AUTOMATIC DELAYED-COMMAND SEQUENCER (SEE COMMAND 033) AND GROUND COMMAND 131, THIS COMMAND MUST BE CONSIDERED CRITICAL BECAUSE OF A POSSIBILITY OF UPLINK FAILURE.

131 FLIP/CAL GO EXP 3 (LSM)

Command 131 is a one-state command that initiates the flip/calibration cycle. Execution of this command activates the flip/cal sequencer, and upon completion of the sequence, the LSM is returned to the normal operating mode and places the sequencer in OFF.

NOTE

THERE MUST BE EXACTLY FOUR FLIP/CALIBRATE CYCLES BEFORE PERFORMING A SITE SURVEY. In addition to ground Command 131, the flip/calibrate delayed-command sequencer (see Command 033) will generate flip/cal commands.

132 LSM FILT IN/OUT EXP 3 (LSM)

Command 132 is a two-state command (IN/OUT). LSM activation initializes the filter to IN. Application of the command to OUT will cause a major portion of the digital filter to be bypassed.

133 SITE SURVEY XYZ EXP 3 (LSM)

Command 133 is a one-state command that activates the site survey sequence generator. The first application of this command will initiate the sequence to survey the X-axis. Upon completion of the X-axis survey, the LSM instrument will return to the normal scientific mode. The second and third application of this command will initiate the sequence generator to survey the Y- and Z-axes, respectively, returning the LSM to the normal mode of operation upon completion of the respective axis survey.

NOTE

THE SITE SURVEY MUST BE PERFORMED
ONLY AFTER FOUR FLIP/CALIBRATE CYCLES
HAVE BEEN COMPLETED.

134 LSM T CTL XYO EXP 3 (LSM)

Command 134 is a three-state command (X, Y, OFF) which is used to select the X- or Y-axis sensor heater thermostat or to deactivate all LSM heater power. LSM activation initializes the temperature control to the X-axis thermostat. Repeated application of this command sequences the temperature control through Y-axis thermostat, off, and X-axis thermostat. The selected axis thermostat (X or Y) controls heater power to all LSM heaters. In the off position, all LSM heater power is removed. Note that there is no thermostat in the Z-axis sensor.

135 HFE MODE/G SEL EXP 4 (HFE)

This command (C1) is a one-state command. It places the HFE in the normal or gradient mode of operation (Mode 1) such that data is obtained from the gradient sensors and cable thermocouples under the control of the measurement sequence programmer. It also turns off the probe heater current supply. At turnon, the HFE is initialized in this condition.

136 HFE MODE/LK SEL EXP 4 (HFE)

This command (C2) is a one-state command. It places the HFE in the low conductivity or ring source mode of operation (Mode 2) such that data is obtained from the gradient sensors and cable thermocouples under the control of the measurement sequence programmer. It also turns on the probe heater current supply in the low (or ring source) mode allowing heaters to be activated via Command 152.

140 HFE MODE/HK SEL EXP 4 (HFE)

This command (C3) is a one-state command. It places the HFE in the high conductivity or heat pulse mode of operation (Mode 3) such that data is obtained from the ring (or remote) sensors under the control of the heater excitation programmer. It also turns on the probe heater current supply in the high (or heat pulse) mode allowing heaters to be activated by Command 152.

141 HFE SEQ/FUL SEL EXP 4 (HFE)

This command (C4) is a one-state command. It cancels the effect of measurement Commands 142 through 146 and thereby causes the measurement sequence programmer to perform its full 16-state cycle of operation. If transmitted during operation in MODE/HK, this command will cause invalid data. At turnon, the HFE is initialized in this condition.

142 HFE SEQ/P1 SEL EXP 4 (HFE)

This command (C5) is a one-state command and alternates with Command 143 to select only one probe for measurement. In MODE/G and MODE/LK it causes the measurement sequence programmer to lock the second flip-flop (P_2) in the clear state and bypass that step; that is, it acts as an eight-state counter if Command 141 was previously executed or as a two-state counter if Command 144, 145, or 146 was previously executed. In MODE/HK this command is meaningless. It is cleared by subsequent execution of Command 141.

143 HFE SEQ/P2 SEL EXP 4 (HFE)

This command (C6) is a one-state command and alternates with Command 142 to select only one probe for measurement. In MODE/G and MODE/LK it causes the measurement sequence programmer to lock the second flip-flop (P_2) in the set state and bypass that step; that is, it acts as an eight-state counter if Command 141 was previously executed or as a two-state counter if Command 144, 145, or 146 was previously executed. In MODE/HK this command is meaningless. It is cleared by subsequent execution of Command 141.

144 HFE LOAD 1 EXP 4 (HFE)

This command (C7) is a one-state command and is used alone or in combination with either Command 145 or 146 to position and lock the measurement sequence programmer's third and fourth flip-flops (P_4P_3). It places these two flip-flops in the clear position (00) and bypasses those steps; thus the MSP acts as a four-state counter if Command 141 was previously executed and as a two-state counter if either Command 142 or 143 was previously executed. In MODE/HK this command must be executed, otherwise the data will be invalid. Subsequent execution (in MODE/G or MODE/LK) of

Command 145 or 146 locks P_4P_3 in the 01 or 10 state respectively. All positioning and locking of P_4P_3 is cleared by subsequent execution of Command 141.

145 HFE LOAD 2 EXP 4 (HFE)

This command (C8) is a one-state command and is used in combination with either Command 144 (preceding 145) or Command 146 (preceding or subsequent to 145) to position and lock P_4P_3 (see 144). It sets P_3 ; therefore, 144 followed by 145 places P_4P_3 in the 01 state. In combination with 146, it places P_4P_3 in the 11 state. Depending on whether Command 141 was previously executed or one of Commands 142 or 143, the MSP acts as a four-state or two-state counter. Execution of this command in MODE/HK causes invalid data until Command 144 is executed. It is cleared by subsequent execution of Command 141.

146 HFE LOAD 3 EXP 4 (HFE)

This command (C9) is a one-state command operating essentially the same as Command 145 except that it sets P_4 . Therefore, when preceded by 144 it places P_4P_3 in the 10 state.

150 TIMER RESET TIMER

Command 150 is a one-state command that will reset timer counters 1 and 2 to a zero count (clear). The 1-minute and the 18-hour output pulses and the timer transmitter turnoff function (at 97 ± 5 days) is referenced to the timer reset. Note that this command does not affect the hours or minutes counters or the sequence decoding gates in the delayed command sequencer or the timer accept/inhibit logic.

NOTE

SINCE THE TIMER TRANSMITTER TURNOFF
FUNCTION CAN ONLY OCCUR ONE TIME, IT
IS MANDATORY THAT COMMAND 150 BE SENT
PRIOR TO TIMER TURNOFF.

152 HFE HTR STEPS EXP 4 (HFE)

This command (C10) is a 16-state command which advances the heater excitation programer ($H_4H_3H_2H_1$) each time the command is executed. In MODE/G the programer advances but there is no other effect since the probe heater current supply is off. In MODE/LK the execution of Command 152 alternates the heater status between on and off, simultaneously stepping through the eight heaters (current supply in on full time, and heater elements are switched in and out of circuit). In MODE/HK the heater excitation programer (advanced by Command 152) also selects the data to be sampled.

NOTE

HFE commands are executed at the ALSEP 90 frame mark; therefore, there must be 54 seconds delta time between transmission of commands to the HFE.

156 GEO CAL GO EXP 2 (ASE)

Command 156 initiates a 1-second calibration pulse which is applied to the three geophones. This calibration pulse permits comparison of the geophone electromechanical parameters with those of preflight calibration.

162 ASE SEQ/S FIRE EXP 2 (ASE)

The repeated transmission of Command 162 will fire rocket motors to sequentially launch grenades 2, 4, 3 and 1, in that order only. Note that GRENADES ARM Command 170 must precede each fire command. The previous grenade must be launched before the next grenade in the order can be fired.

163 GRENADE 1 FIRE EXP 2 (ASE)

Command 163 will fire the rocket motor of grenade 1, if previously armed by Command 170, GRENADES ARM. This

specific fire command (and commands 164, 165 and 166) provides an alternative to sequential Command 162 for launching the grenades. Note that only Command 162 provides a predetermined firing order.

164 GRENADE 2 FIRE EXP 2 (ASE)

Command 164 will fire the rocket motor of grenade 2, if previously armed by Command 170, GRENADES ARM. See Command 163.

165 GRENADE 3 FIRE EXP 2 (ASE)

Command 165 will fire the rocket motor of grenade 3, if previously armed by Command 170, GRENADES ARM. See Command 163.

166 GRENADE 4 FIRE EXP 2 (ASE)

Command 166 will fire the rocket motor of grenade 4, if previously armed by Command 170, GRENADES ARM. See Command 163.

NOTE

ALL ASE FIRE COMMANDS (162, 163, 164, 165, 166) ARE CONSIDERED CRITICAL.

170 GRENADES ARM EXP 2 (ASE)

Command 170 arms the grenade firing circuits by charging two capacitors, one for sequential firing and one for specific grenade firing. This command also charges the thermal battery ignition capacitors in all grenades. All of the above capacitors will remain charged (armed) indefinitely provided the ASE remains in operate mode and no fire command has been sent. Transmission of a fire command after arming will fire one rocket motor and discharge all capacitors. All capacitors can be safed (discharged) by

placing the ASE in standby select.

NOTE

A minimum of 60 seconds must be allowed between the GRENADES ARM command and any of the fire commands to allow sufficient time for charging the firing circuits.

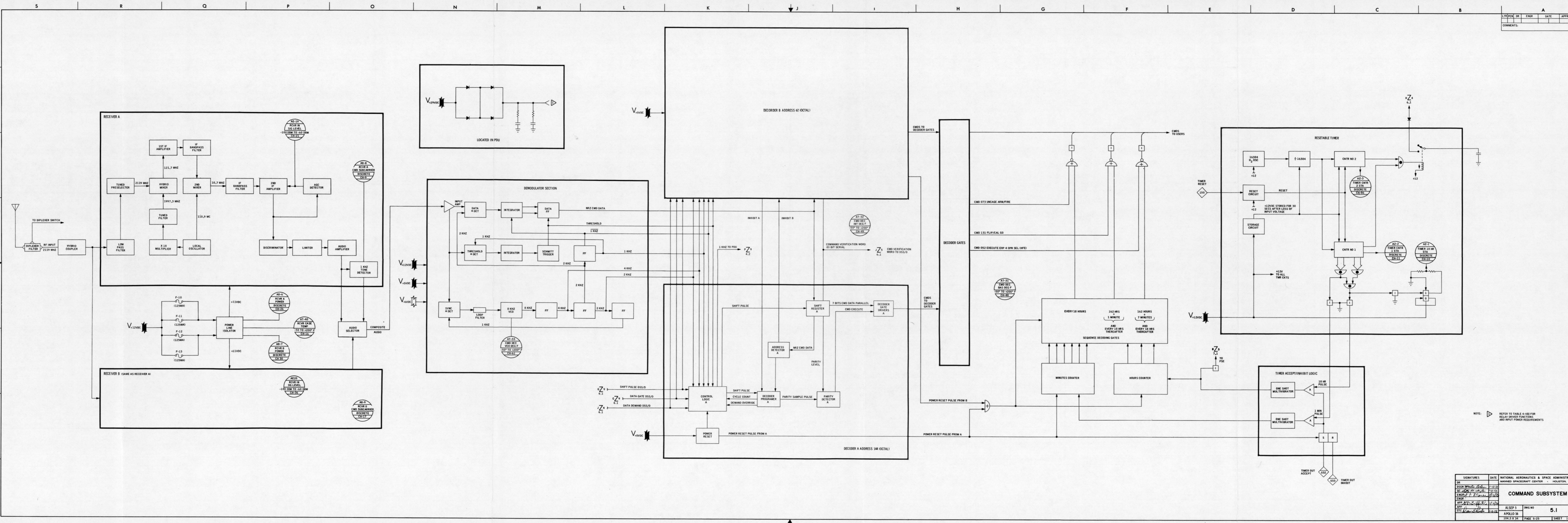

NOTE: REFER TO TABLE 4-VII FOR RELAY DRIVER FUNCTIONS AND INPUT POWER REQUIREMENTS

6 TELEMETRY
SUBSYSTEM

SECTION 6

TELEMETRY SUBSYSTEM

6.1 SYSTEM DESCRIPTION

The telemetry subsystem consists of central station sensors, experiment sensors, two analog multiplexers, two analog-to-digital converters, two digital data processors, two S-band transmitters, one diplexer switch, one diplexer filter, and a common S-band transmit/receive helix antenna.

6.1.1 Sensors (Transducers)

Analog sensors convert such parameters as temperature, voltage, current, and status into 0- to +5-volt signals and input these signals to the 90-channel analog multiplexers as engineering (housekeeping) data to indicate the condition of the central station, RTG, PSE, and HFE.

Scientific measurements from the experiment sensors and experiment status, calibration, and temperature data are converted within each experiment to digital data and applied to the X and Y digital data processors at the proper demand time in serial form.

6.1.2 Analog Multiplexers

Analog engineering (housekeeping) data are applied to the redundant 90-channel analog multiplexers. Selection of the redundant multiplexer can be accomplished by Command 034 or 035. Actuation of astronaut switch 2 provides the same function as ground Command 035 (DSS/PROC Y SEL). The multiplexer is divided into 15 groups of six column gates each, and the group outputs are further gated through a tier of eight row gates. The channel advance pulse generated in the digital data processor (occurs at the time of the sixty-fourth

main frame word) is applied to the analog multiplexer sequencers to advance the multiplexers to the next channel after each A/D conversion. The sequencers generate a ninetieth-channel output pulse that is used to reset the frame counter located in the digital data processor. The output of the analog multiplexer is buffered by amplifiers at the input to each A/D converter.

6.1.3 A/D Converters

The A/D converters encode the analog signal from the multiplexer into an 8-bit digital word when an encode pulse from the digital data processor occurs (once every digital data processor main frame). The 8-bit digital word is input parallel to the digital data processor at Word 33 time of the ALSEP main frame. Selection of the redundant A/D converter is accomplished by Command 034 or 035.

6.1.4 Digital Data Processor

6.1.4.1 Normal and low bit rates.— Redundant digital data processors (X and Y) are provided. The redundant processors are selectable by ground Command 034 or 035. The processor that is selected receives data in a parallel form from the A/D converter and in a serial form from the command decoder and experiments. The data are formatted into a serial NRZC format and then encoded into a split-phase signal and applied to the transmitter.

As a backup capability, the data processor provides a low-bit-rate mode at one-half the normal data rate. The normal or low data rate can be selected by ground Commands 006 and 007 respectively.

The first three words of the ALSEP main frame are used for the sync code. The bit assignment for the sync word is shown in Figure 6-3. Bits 23 through 29 are provided for channel

*

identification for 1 through 90 channels for correlation of the analog multiplexer data. These bits are derived from a ripple-through counter which is advanced one step whenever Word 1 of the ALSEP main frame occurs and is reset by a ninetyeth-frame signal generated by the analog multiplexers. When power is applied to the data processor, these seven bits will be a random count between 0 and 127 and cannot be used to determine the position of the multiplexers until the ninetyeth-frame reset signal is received from the analog multiplexers.

Each of the redundant processors has a power reset circuit. This circuit will reset the processor to the normal data rate if there is a momentary drop in the +5 Vdc line.

The data processor will generate and provide all necessary timing signals to the experiments, command decoder, A/D converter, and the 90-channel analog multiplexers (see Table 6-III).

6.1.4.2 ASE high bit rate.- Upon execution of Command 003 (ASE HBR ON) or actuation of Astronaut Switch No. 4, the data processor in use (X or Y) will perform the following functions at the end of the ALSEP frame in progress (Word 64):

- A. Inhibit data demand timing signals to all experiments and command decoder.
- B. Gate on active-seismic serial data to the NRZC/split-phase converter in the data processor for downlinking.
- C. Inhibit PSE, HFE, LSM, command decoder, and analog multiplexer data normally applied to the NRZC/split-phase converter.
- D. Change NRZC/split-phase converter clock rate to 10.6 kbps.
- E. Continue to output all timing signals except data demand, to the PSE, HFE, LSM, command decoder, and analog A/D converter/multiplexer at a rate determined by the last Command 006 (NORM BIT RT SEL) or Command 007 (LOW BIT RT SEL) executed, as listed in Table 6-III.

The data processor multiformat commutator also continues at the above determined rate.

The active-seismic serial data is formatted within the ASE into thirty-two 20-bit words per ASE frame. Each 20-bit word consists of four 5-bit subwords. The data rate of 10.6 kbps in NRZC form is converted to split phase and applied to the transmitter in the normal manner.

The functions performed in the data processor, when in the HBR mode, preclude any other experiment data or command decoder CVW's being downlinked.

Execution of Command 005 (ASE HBR OFF) or actuation of Astronaut Switch No. 5 will functionally reverse items A through D above and return the data processor to the mode of operation last executed by Command 006 or Command 007. Since the data processor multiformat commutator operates continuously, Command 005 will take effect at the end of the end of the ALSEP frame in progress (Word 64).

A power reset (Para 6.1.4) or the execution of Command 011 (NORM BT RT RST) will cause the data processor to return to the normal data rate (1060 BPS) from either the HBR or LBR immediately and not wait until the end of the ALSEP frame.

6.1.5 Transmitter

There are two S-band transmitters (A and B) which are selectable by ground commands. The active transmitter accepts split-phase telemetry data from the data processor and phase-modulates the carrier which is applied to the helix antenna at a 1-watt level on a downlink frequency of 2276.0 MHz. Ground commands are also used to turn the selected transmitter on or off. If the transmitter is commanded off, an 8.4-watt heater is simultaneously activated to provide electrical and thermal balance. Overload protection is provided for both transmitters. The circuit breaker associated with the overloaded transmitter will switch the operating voltage (+29 Vdc) to the other transmitter.

*

6.1.6 Diplexer Switch

The diplexer switch is utilized to couple the selected transmitter (A or B) output through the diplexer filter to the antenna. The direction of the diplexer switch (thus the selection of transmitter A or B output) is controlled by activating a ferrite device, within the circulator, by a magnetic field from a coil which is energized by +12 Vdc. The +12 Vdc is applied when transmitter B is on.

TABLE 6-I.- ANALOG MULTIPLEXER, A/D CONVERTER CHARACTERISTICS

Analog multiplexer (subcommutated)

Input (from sensors or signal conditioners) . . . 0 to +5 Vdc

Channels/frame 90 max

Seconds/frame (normal bit rate) 54.34

Seconds/frame (low bit rate) 108.68

Redundancy X or Y multiplexer

A/D converters

Input (from analog mux) 0 to +5 Vdc

Conversion 8 bits

Data to D/P Parallel

Time slot in main frame Word 33

Redundancy X or Y converter

Input from 0 to +5 volts Outputs 0 to 225
PCM count

Input from +5 to +8 volts Outputs 255 decimal
PCM count

Input from +8 to +12 volts Outputs ambiguous counts
(0-255)

Input above +12 volts Detrimental to the
analog mux

TABLE 6-II.- DIGITAL DATA PROCESSOR CHARACTERISTICS

Parameter	Low bit rate	Normal bit rates	High bit rate**
Data rate (bps)	530	1060	10,600
Bits/word	10	10	20
Words/frame . . .	64	64	32
Frame/second . .	53/64	1-21/32	16.56
Seconds/frame . .	1.2075	0.6038	0.06038
Bits/sync word .	22	22	10
Redundancy . . .	X or Y processor		

**Each ASE word of 20 bits is composed of four 5-bit subwords. When in HBR, only ASE data is downlinked.

Words 1, 2, and 3 are control words. Word 33 of the main frame contains housekeeping data from the analog mux/A/D converter. Word 46 contains the command verification word. The two MSB's of Words 33 and 46 are filler bits inserted by the digital data processor. All main frame words are downlinked MSB first.

DA-4 (Bit 10 of Word 3) contains the data processor serial number.

Frame 3	0 MSB
Frame 4	0
Frame 5	1

NOTE

Either of the two systems, X or Y (redundant analog multiplexers, A/D converters, and digital data processors) are selected by Command 034 (DSS/PROC X SEL) or Command 035 (DSS/PROC Y SEL).

TABLE 6-III.- TIMING FROM DIGITAL PROCESSOR

Signals from data processor	Signal to -					
	Cmd decoder	PSE	LSM	ASE	HFE	Analog mux and A/D conv
Shift pulse	X	X	X	X*	X	
Data gate	X	X				
Even frame mark		X				
Frame mark			X		X	
Data demand	X	X	X		X	
A/D encode						X
Advance pulse						X
90th frame mark					X	

*Shift Pulse Rate = 10.6 kbps

TABLE 6-IV.- TIMING AND CONTROL PULSE CHARACTERISTICS

Pulse type	Duration ^a (μsec)	Repetition rate
Frame mark	118	Once per ALSEP frame
Even frame mark	118	Once every other frame
90th frame mark	118	Once every 90th frame
Data gate (word mark)	118	64, once per each 10-bit word in frame
Data demand	9434	Once per word in ALSEP frame
Shift pulse	47	640 pulses per frame 1060 pulses per second
Command	20,000	Asynchronous

^aIn low bit rate, duration is twice the normal mode.

1	2	3	4	5	6	7	8
x	x	x	X	0	X		X
9	10	11	12	13	14	15	16
-	X	-	X	-	X		X
17	18	19	20	21	22	23	24
0	X	0	X	0	X	HF	X
25	26	27	28	29	30	31	32
-	X	-	X	-	X		X
33	34	35	36	37	38	39	40
H	X	•	X	•	X		X
41	42	43	44	45	46	47	48
-	X	-	X	-	CV		X
49	50	51	52	53	54	55	56
0	X	0	X	0	X		
57	58	59	60	61	62	63	64
-	X	-	X	-	X		X

Legend

- x - Control
- X - Passive Seismic - Short Period
- - Passive Seismic - Long Period Seismic
- - Passive Seismic - Long Period Tidal and One Temperature
- 0 - Magnetometer
- HF - Heat Flow
- CV - Command Verification (upon command, otherwise all zeros)
- H - Housekeeping
- - Not Used

Number of
Words Per
Frame

3
29
12
2
7
1
1
1
8
<hr/> 64

Total

Each box contains one 10 bit word
Total bits per frame - 10 x 64 = 640 bits

Figure 6-2.- ALSEP word assignment for array D.

CONTROL GROUP FORMAT

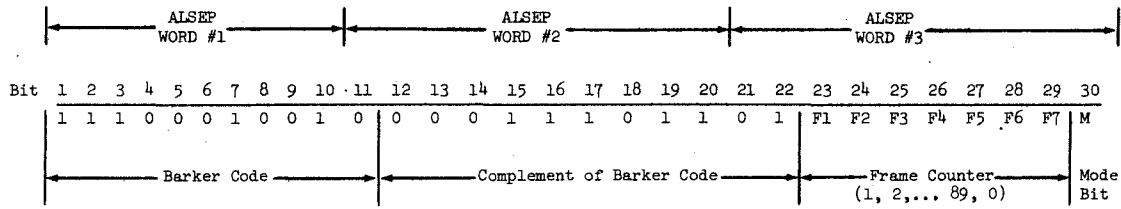

Symbol	Name	ALSEP Words	Range	Bits/ Sample	Samples/ Second
DA-1	Barker Code and Complement	1, 2, and Bits 1 and 2 of Word 3	NA	22	1.67
DA-2	Frame Count	Bits 3 to 9 inclusive of Word 3	0-127 (Frame count reads all zero's on channel 90)	7	1.67
DA-3	Bit Rate ID	Bit 10 of Word 3		1	1.67
		<u>Frame</u> <u>Mode Bit</u>	<u>Meaning</u>		
		1 1	Normal data rate		
		2 1	Low data rate		
DA-4	ALSEP ID	Bit 10, LSB, of Word 3		3	1/54
		<u>Frame</u> <u>Mode Bit</u>			
		3 0 (MSB)	Data processor Serial number ALSEP D		
		4 0			
		5 1			
DA-5	Received Command Message	Bits 3 to 9 inclusive of Word 46	1 to 127	7	*
DA-6	Command MAP	Bit 10, LSB, of Word 46	"0" no parity "1" parity	1	*
DA-7	Filler Bits	May be used to determine bit error rate during off line processing. Bits 1 and 2 of Word 46.			

*One word sample is sent for each command received; other samples are all zeros.

Figure 6-3.- Control and command verification word format.

TABLE 6-V.- TELEMETRY SUBSYSTEM POWER REQUIREMENTS AND OVERLOAD PROTECTION

Component	Voltage bus	Watts	mAdc	Circuit protection
Digital data processor, X or Y	+12 Vdc \pm 1%	0.05		None
	+5 Vdc \pm 1%	0.450		None
Analog multiplexer and A/D converter, X or Y	+15 Vdc \pm 1%	0.05		None
	+12 Vdc \pm 1%	0.140		None
	+5 Vdc \pm 1%	1.10		None
	-12 Vdc \pm 1%	0.11		None
Transmitter A or B	+29 Vdc \pm 1%	10.8	375.0	CB-03 Xmtr A 560 to 840 mA CB-05 Xmtr B 560 to 840 mA
Transmitter heater	+29 Vdc \pm 1%	8.4		None
Diplexer switch	+12 Vdc \pm 1%	0.15	12.5	CB-04 110 to 225 mA

TABLE 6-VI.- TRANSMITTER CHARACTERISTICS

Frequency 2276.0 MHz
 Modulation PM \pm 1.25 radian, phase-modulated carrier
 Stability (long-term) . . . \pm 0.0025 percent/year
 Power output 1 watt minimum
 Power input 10.0 to 10.8 watts
 TM parameters 4

TABLE 6-VII.- CHANNEL AND MEASUREMENT ASSIGNMENTS FOR ANALOG MULTIPLEXER (ALSEP WORD 33)

Channel Number	Symbol	Location/Name	Channel Number	Symbol	Location/Name
1	AE-3	Converter Input Voltage	46	AT-29	Digital D/P, Base Temp
2	AE-1	0.25 Vdc Calibration	47	AT-30	Digital D/P, Internal Temp
3	AE-2	4.75 Vdc Calibration	48	AT-31	Command Decoder Base Temp
4	AT-3	Thermal Plate Temp 1	49	AT-32	Command Decoder Internal Temp
5	AE-4	Converter Input Current	50	AE-9	PCU Output Voltage 3 (12 V)
6	AR-1	RTG Hot Frame 1 Temp	51	AE-15	Transmitter A, RF Power
7	AR-4	RTG Cold Frame 1 Temp	52	AR-3	RTG Hot Frame 3 Temp
8	AE-5	Shunt Regulator 1 Current	53	AL-3	Level Direction and Speed
9	AB-8	Receiver A IKC Status	54	AL-7	Calibration and Status LP and SP
10	AZ-1	Timer 18 Hr Status	55	AH-3	HFE Supply Voltage No. 3 (15 V)
11	AZ-2	Timer Counter No. 1 Status	56	AE-5	Shunt Regulator 1 Current
12	AB-4	Power Distribution Exper 1 and 2 Standby Status	57	AH-6	HFE Low Conductivity Htr Status
13	AE-6	Shunt Regulator 2 Current	58	AT-6	Thermal Plate Temp 4
14	AB-5	Power Distribution Exper 3, 4, 5 Standby Status	59	AT-8	Primary Structure Wall Temp 1 (Left)
15	AT-10	Primary Structure Bottom Temp 1	60	AT-12	Insulation Inner Temp
16	AT-40	Receiver Case Temp	61	AT-33	Command Demodulator, VCO Temp
17	AB-9	Receiver B IKC Status	62	AT-34	Power Distribution, Base Temp
18	AT-23	Transmitter A Crystal Temp	63	AT-35	Power Distribution, Internal Temp
19	AT-24	Transmitter A Heat Sink Temp	64	AT-36	PCU, Power Oscillator 1 Temp
20	AE-7	PCU Output Voltage 1 (29 V)	65	AE-10	PCU Output Voltage 4 (5 V)
21	AE-19	Receiver A Input Sig	66	AE-16	Transmitter B, R.F. Power
22	AE-18	Transmitter B Current	67	AR-5	RTG Cold Frame 2 Temp
23	AL-1	LP Amplifier Gain (X and Y)	68	AL-4	SP Amplifier Gain (Z)
24	AL-5	Leveling Mode and Coarse Sensor Mode	69	AL-8	Uncage Status
25	AS-1	Central Station Pkg Temp (ASE)	70	AB-10	D/P X On/Off Status
26	AB-6	Receiver A Pwr Status	71	AT-7	Thermal Plate Temp 5
27	AT-1	Sunshield Temp 1	72	AT-13	Insulation Outer Temp
28	AT-4	Thermal Plate Temp 2	73	AS-4	Geophone Temp (ASE)
29	AH-1	HFE Supply Voltage No. 1 (5 V)	74	AH-4	HFE Supply Voltage No. 4 (-15 V)
30	AB-7	Receiver B Pwr Status	75	AH-7	HFE High Conductivity Htr Status
31	AT-25	Transmitter B Crystal Temp	76	AT-37	PCU, Power Oscillator 2 Temp
32	AT-26	Transmitter B Heat Sink Temp	77	AT-38	PCU, Regulator 1 Temp
33	AT-27	Analog DP, Base Temp	78	AT-39	PCU, Regulator 2 Temp
34	AT-28	Analog DP, Internal Temp	79	AE-11	PCU Output Voltage 5 (-12 V)
35	AE-8	PCU Output Voltage 2 (15 V)	80	AE-12	PCU Output Voltage 6 (-6 V)
36	AE-20	Receiver B Input Sig	81	AE-17	Transmitter A Current
37	AR-2	RTG Hot Frame 2 Temp	82	AR-6	RTG Cold Frame 3 Temp
38	AL-2	LP Amplifier Gain (Z)	83	BLANK	
39	AL-6	Thermal Control Status	84	BLANK	
40	AS-2	Mortar Box Temp (ASE)	85	BLANK	
41	AE-6	Shunt Regulator 2 Current	86	AZ-3	Timer Counter No. 2 Status
42	AT-2	Sunshield Temp 2	87	AT-9	Primary Structure Wall Temp 2 (Right)
43	AT-5	Thermal Plate Temp 3	88	AT-11	Primary Structure Wall Temp 3 (Back)
44	AS-3	Grenade Launcher Temp (ASE)	89	BLANK	
45	AH-2	HFE Supply Voltage No. 2 (-5 V)	90	BLANK	

6-12

ALSEP 3
 BASIC

TABLE 6-VIII.- ANALOG CHANNEL USAGE

CENTRAL STATION:

Symbol	Location/Name	Channel	Nominal Operating Limits		Nom Oper Value
			Low	High	
<u>Structural/Thermal Temperatures (Fahrenheit)</u>					
AT-1	Sunshield Temp 1	27	-245°	165°	-80°
AT-2	Sunshield Temp 2	42	-245°	165°	-80°
AT-3	Thermal Plate Temp 1	4	-20°	140°	83°
AT-4	Thermal Plate Temp 2	28	-20°	140°	83°
AT-5	Thermal Plate Temp 3	43	-20°	140°	83°
AT-6	Thermal Plate Temp 4	58	-20°	140°	83°
AT-7	Thermal Plate Temp 5	71	-20°	140°	83°
AT-8	Primary Structure Wall Temp 1 (Left)	59	-210°	236°	0°
AT-9	Primary Structure Wall Temp 2 (Right)	87	-210°	236°	0°
AT-10	Primary Structure Bottom Temp 1	15	-210°	258°	6°
AT-11	Primary Structure Wall Temp 3 (Back)	88	-300°	315°	28°
AT-12	Insulation Inner Temp	60	-20°	157°	64°
AT-13	Insulation Outer Temp	72	-135°	210°	26°
<u>Electronic Temperatures (Fahrenheit)</u>					
AT-23	Transmitter A Crystal Temp	18	-10°	140°	75°
AT-24	Transmitter A Heat Sink Temp	19	-10°	145°	75°
AT-25	Transmitter B Crystal Temp***	31	-10°	140°	75°
AT-26	Transmitter B Heat Sink Temp***	32	-10°	145°	75°
AT-27	Analog D/P, Base Temp	33	-20°	140°	83°
AT-28	Analog D/P, Internal Temp	34	-7°	130°	90°
AT-29	Digital D/P, Base Temp	46	-10°	125°	83°
AT-30	Digital D/P, Internal Temp	47	-12°	148°	87°
AT-31	Command Decoder, Base Temp	48	-10°	140°	83°
AT-32	Command Decoder, Internal Temp	49	-10°	145°	86°
AT-33	Command Demodulator, VCO Temp	61	-10°	145°	86°
AT-34	Power Distribution Unit, Base Temp	62	-10°	140°	83°
AT-35	Power Distribution Unit, Internal Temp	63	10°	150°	100°
AT-36	PCU, Power Oscillator 1 Temp	64	-10°	165°	94°
AT-37	PCU, Power Oscillator 2 Temp	76	-10°	165°	94°
AT-38	PCU, Regulator 1 Temp	77	-10°	195°	103°
AT-39	PCU, Regulator 2 Temp	78	-10°	195°	103°
<u>Central Station Electrical</u>					
AE-1	0.25 Vdc Calibration	2	.24V	.26V	.25V
AE-2	4.75 Vdc Calibration	3	4.72V	4.78V	4.75V
AE-3	Converter Input Voltage	1	15.4V	16.9V	16.2V
AE-4	Converter Input Current	5	3.9A	4.7A	4.2A
AE-5	Shunt Regulator 1 Current	8 & 56	0.3A	2.7A	1.1A
AE-6	Shunt Regulator 2 Current***	13 & 41	0.3A	2.7A	1.1A
AE-7	PCU Output Voltage 1 (29 V)	20	28.0V	30.0V	29.0V
AE-8	PCU Output Voltage 2 (15 V)	35	14.5V	15.6V	15.0V
AE-9	PCU Output Voltage 3 (12 V)	50	11.75V	12.25V	12.0V
AE-10	PCU Output Voltage 4 (5 V)	65	4.75V	5.3V	5.0V
AE-11	PCU Output Voltage 5 (-12 V)*	79	-12.75V	-11.9V	-12.0V
AE-12	PCU Output Voltage 6 (-6 V)*	80	-6.2V	-5.9V	-6.0V
AE-19	Rcvr A Input Sig Level	21	-350dbm	-5 dbm	-88 dbm
AE-20	Rcvr B Input Sig Level	36	4.5dbm	7.5dbm	6.1dbm
AE-15	Transmitter A, RF Power	51			
AE-16	Transmitter B, RF Power***	66			
AE-17**	Transmitter A Current	81			
AE-18**	Transmitter B Current***	22			

*AE-11 and AE-12 values also vary with changes of PCU output voltage 1 (29V), AE-7.

**Temperature dependent.

***Redundant functions, not normally active.

TABLE 6-VIII.- ANALOG CHANNEL USAGE - Concluded

Symbol	Location/Name	Channel	Nominal Operating Limits		Nom Oper Value	Redline Limits	
			Low	High		Low	High
<u>RTG Temperatures (Fahrenheit)</u>							
AR-1	Hot Frame 1 Temp	6	1060°	1150°	1107°		
AR-2	Hot Frame 2 Temp	37	1060°	1150°	1107°		
AR-3	Hot Frame 3 Temp	52	1060°	1150°	1107°		
AR-4	Cold Frame 1 Temp	7	415°	500°	450°		
AR-5	Cold Frame 2 Temp	67	400°	470°	430°		
AR-6	Cold Frame 3 Temp	82	415°	500°	450°		
<u>Central Station Discretes</u>							
			Value in Decimal PCM				
AB-4	Power Distribution Experiment 1 and 2 Standby Status	12	<u>Exper 1</u> Standby-off Standby-on Standby-off Standby-on	<u>Exper 2</u> Standby-off Standby-off Standby-on Standby-on		1 ± 1 72 ± 10 131 ± 10 192 ± 12	
AB-5	Power Distribution Experiment 3, 4, and 5 Standby Status	14	<u>Exper 3</u> Standby-off Standby-off Standby-off Standby-on Standby-on Standby-on Standby-on	<u>Exper 4</u> Standby-off Standby-off Standby-on Standby-off Standby-off Standby-on Standby-on	<u>Exper 5</u> Standby-off Standby-on Standby-on Standby-on Standby-off Standby-on Standby-off Standby-on	1 ± 1 35 ± 10 69 ± 10 100 ± 10 131 ± 10 160 ± 10 188 ± 10 214 ± 10	
AB-6	Rec A Pwr Status	26					
AB-7	Rec B Pwr Status	30					
AB-8	Rec A CMD Subcarrier Status	9	No modulation 0 to 76, no carrier 128 to 255 Modulation 77 to 127				
AB-9	Rec B CMD Subcarrier Status	17					
AB-10	Data Processor X On/Off Status	70	X processor on PCM > 128 X processor off PCM < 32				
AZ-1	Timer 18 Hr Status	10	0 to 18 hrs PCM < 32 } Alternates every 18 hours 18 to 36 hrs PCM > 128 }				
AZ-2	Timer Counter 1 Status	11	0 to 1-1/2 months PCM < 32 } Alternates every 1-1/2 months 1-1/2 to 3 months PCM > 128 }				
AZ-3	Timer Counter 2 Status	86	0 to 1-1/2 months PCM < 32 } Alternates every 1-1/2 months 1-1/2 to 3 months PCM > 128 }				

EXPERIMENTS:

Symbol	Location/Name	Channel	Nominal Operating Limits	
<u>Passive Seismic</u>				
AL-1	LP Amplifier Gain (X and Y)	23	Discrete	
AL-2	LP Amplifier Gain (Z)	38	Discrete	
AL-3	Level Direction and Speed	53	Discrete	
AL-4	SP Amplifier Gain (Z)	68	Discrete	
AL-5	Leveling Mode and Coarse Sensor Mode	24	Discrete	
AL-6	Thermal Control Status	39	Discrete	
AL-7	Calibration Status LP and SP	54	Discrete	
AL-8	Uncage Status	69	Discrete	
<u>Active Seismic (ASE in Standby, HBR OFF only)</u>				
AS-1	ASE Int Pkg Deg C	25	-20° to +60° C	
AS-2	Mortar Box Deg C	40	-60° to +85° C	
AS-3	ASE GLA Deg C	44	-60° to +85° C	
AS-4	Geophone Deg C	73	-200° to +130° C	
<u>Heat Flow</u>				
AH-1	Supply Voltage 1 (5 V)	29	4.9 to 5.1 Vdc	
AH-2	Supply Voltage 2 (-5 V)	45	-4.9 to -5.1 Vdc	
AH-3	Supply Voltage 3 (15 V)	55	14.7 to 15.3 Vdc	
AH-4	Supply Voltage 4 (-15 V)	74	-14.7 to -15.3 Vdc	
AH-5	Not Assigned			
AH-6	Low Cond Heater Power Status	57	Discrete	
AH-7	High Cond Heater Power Status	75	Discrete	

TABLE 6-IX.- PSE MEASUREMENTS

Scientific Measurements

Symbol	Location/Measurement	ALSEP Word	ALSEP Frame	Sensor Range
DL- 1	Long Period X Seismic	9, 25, 41, 57	Every	1 mμ to 10μ
DL- 2	Long Period Y Seismic	11, 27, 43, 59	Every	1 mμ to 10μ
DL- 3	Long Period Z Seismic	13, 29, 45, 61	Every	1 mμ to 10μ
DL- 4	Long Period X Tidal	35	Even	±24 μradians
DL- 5	Long Period Y Tidal	37	Even	±24 μradians
DL- 6	Long Period Z Tidal	35	Odd	±4 mgal
DL- 7	Instrument Temp	37	Odd	107 - 143°F
DL- 8	Short Period Z Seismic	Every Even Word Except 2, 24, 46, 56	Every	1 mμ to 10μ

Engineering Measurements

8 channels of Engineering Measurements included in ALSEP Word 33

Symbol	Location/Measurement	Analog Channel	Sensor Range	Decimal PCM	
AL- 1	LP Ampl Gain (X and Y)	23	0 db	0-0.4V	0-21
			-10db	0.6-1.4	31-72
			-20db	1.6-2.4	82-122
			-30db	2.6-4.0	133-204
AL- 2	LP Ampl Gain (Z)	38	0 db	0-0.4V	0-21
			-10db	0.6-1.4	31-72
			-20db	1.6-2.4	82-122
			-30db	2.6-4.0	133-204
AL- 3	Level Direction and Speed	53	+low	0-0.4V	0-21
			-low	0.6-1.4	31-72
			+high	1.6-2.4	82-122
			-high	2.6-4.0	133-204
AL- 4	SP Ampl Gain (Z)	68	0 db	0-0.4V	0-21
			-10db	0.6-1.4	31-72
			-20db	1.6-2.4	82-122
			-30db	2.6-4.0	133-204
AL- 5	Leveling Mode and Coarse Sensor Mode	24	Automatic, coarse sensor out	0-0.4V	0-21
			Forced, coarse sensor out	0.6-1.4	31-72
			Automatic, coarse sensor in	1.6-2.4	82-122
			Forced, coarse sensor in	2.6-4.0	133-204
AL- 6	Thermal Control Status	39	Automatic Mode ON	0-0.4V	0-21
			Automatic Mode OFF	0.6-1.4	31-72
			Forced Mode ON	1.6-2.4	82-122
			Forced Mode OFF	2.6-4.0	133-204
AL- 7	Calibration Status LP & SP	54	All ON	0-0.4V	0-21
			LP - ON, SP - OFF	0.6-1.4	31-72
			LP - OFF, SP - ON	1.6-2.4	82-122
			All OFF	2.6-4.0	133-204
AL- 8	Uncage Status	69	Caged	0-0.4V	0-21
			Arm	0.6-1.4	31-72
			Uncage	1.6-2.4	82-122

TABLE 6-X.- LSM MEASUREMENTS

Scientific Measurements

Symbol	Location/Measurement	ALSEP Word	Frame	Range
DM-25	LSM X-Axis Field	17,49	Every	±50,±100,±200 gamma
DM-26	LSM Y-Axis Field	19,51	Every	±50,±100,±200 gamma
DM-27	LSM Z-Axis Field	21,53	Every	±50,±100,±200 gamma

These data are in Words 17, 19, 21, 49, 51, 53 and have the following format:

	2 ⁹	2 ⁸	2 ⁷	2 ⁶	2 ⁵	2 ⁴	2 ³	2 ²	2 ¹	2 ⁰
*Polarity Bit	Science Data									

*0 = Plus 1, 1 = Minus

Engineering Measurements

Housekeeping is located in ALSEP Word 5 which is subcommutated over 16 frames as follows:

Bit in Word 5	2 ⁹	2 ⁸	2 ⁷	2 ⁶	2 ⁵	2 ⁴	2 ³	2 ²	2 ¹	2 ⁰
Meaning	F	A1	A2	A3	A4	A5	A6	A7	B1	B2
		Engineering Data							Status Bits	

Where B1, B2 are bistable status data

A1,, A7 are bits derived from analog measurements

F locates the subcommutation start, F = 1 is Frame 1 of the subcommutation and F = 0 elsewhere.

Symbol	Location/Measurement	ALSEP Word	Frame	Sensor Range		
DM-1	Sensor X Temp	5	1,9	-30°C to +65°C		
DM-2	Sensor Y Temp		2,10	-30°C to +65°C		
DM-3	Sensor Z Temp		3,11	-30°C to +65°C		
DM-4	Base Temp		4,12	-30°C to +65°C		
DM-5	Internal Temp		5,13	-30°C to +65°C		
DM-6	Level Sensor 1		6,14	-15° to +15° (arc)		
DM-7	Level Sensor 2		7,15	-15° to +15° (arc)		
DM-8	Supply Voltage		8,16	0 to +6.25Vdc		
DM-9	X Flip Position	5	1	Discrete	} See Table 6-XI (LSM) Page 6-17	
DM-10	Y Flip Position	5	2	Discrete		2 status bits
DM-11	Z Flip Position	5	3	Discrete		2 status bits
DM-12	X Gimbal Position	5	4	Discrete		1 status bit
DM-13	Y Gimbal Position	5	4	Discrete		1 status bit
DM-14	Z Gimbal Position	5	5	Discrete		1 status bit
DM-15	Thermal Control State	5	5	Discrete		1 status bit
DM-16	Measurement Range	5	7	Discrete		2 status bits
DM-17	X Offset Field	5	9,10	Discrete		3 status bits
DM-18	Y Offset Field	5	10,11	Discrete		3 status bits
DM-19	Z Offset Field	5	12,13	Discrete		3 status bits
DM-20	Scientific/Calibrate Mode	5	13	Discrete		1 status bit
DM-21	Offset Axis Address	5	14	Discrete		2 status bits
DM-22	Filter ON/OFF Status	5	15	Discrete		1 status bit
DM-23	Flip/Cal Inhibit Status	5	15	Discrete		1 status bit
DM-24	Filler Bits	5	16	Discrete		2 status bits
DM-28	Heater ON/OFF	5	6	Discrete	1 status bit	
DM-29	Filler Bits	5	8	Discrete	3 status bits	
DM-30	Frame Number	5	(Derived from F in Frame 1)			

* Table 6-XI.- LSM 16 POINT ENGINEERING SUBCOMMUTATION FORMAT AND ENGINEERING STATUS
BIT STRUCTURE LOCATED IN ALSEP MAIN FRAME, WORD 5

Frame Mark Bit	Engineering Parameter	Status Parameter	Subcommutation Frame	B ₁	B ₂	Status
1	Sensor X Temp	X-axis Flip Position	1	0	0	Not at 0°, 90°, or 180° position 0° position 90° position 180° position
		X-axis Flip Position	1	0	1	
		X-axis Flip Position	1	1	0	
		X-axis Flip Position	1	1	1	
0	Sensor Y Temp	Y-axis Flip Position	2	0	0	Not at 0°, 90°, or 180° position 0° position 90° position 180° position
		Y-axis Flip Position	2	0	1	
		Y-axis Flip Position	2	1	0	
		Y-axis Flip Position	2	1	1	
0	Sensor Z Temp	Z-axis Flip Position	3	0	0	Not at 0°, 90°, or 180° position 0° position 90° position 180° position
		Z-axis Flip Position	3	0	1	
		Z-axis Flip Position	3	1	0	
		Z-axis Flip Position	3	1	1	
0	Base Temp	X-axis Gimbal Position	4	1		Pre Site Survey Position
		X-axis Gimbal Position	4	0		Post Site Survey Position
		Y-axis Gimbal Position	4	1		Pre Site Survey Position
		Y-axis Gimbal Position	4	0		Post Site Survey Position
0	Internal Temp	Z-axis Gimbal Position	5	1		Pre Site Survey Position
		Z-axis Gimbal Position	5	0		Post Site Survey Position
		Temp Control State	5	1		X-axis Control
		Temp Control State	5	0		Y-axis Control/OFF
0	Level Sensor 1	Heater Power Status	6	1	1	Heater ON
		Heater Power Status	6	1	0	Heater OFF
0	Level Sensor 2	Measurement Range	7	0	0	50 γ Range
		Measurement Range	7	1	0	100 γ Range
		Measurement Range	7	1	1	200 γ Range
		Measurement Range	7	0	1	Error
0	Supply Voltage 1	Filler Bits	8	1	1	Not used
0	Sensor X Temp	X-axis Field Offset	9	0	1	0% offset
0	Sensor Y Temp	X-axis Field Offset	10	1	1	0% offset
		X-axis Field Offset	9	1	0	-25% offset
		X-axis Field Offset	10	0	0	-25% offset
		X-axis Field Offset	9	1	0	-50% offset
		X-axis Field Offset	10	1	1	-50% offset
		X-axis Field Offset	9	1	1	-75% offset
		X-axis Field Offset	10	0	0	-75% offset
		X-axis Field Offset	9	0	0	+75% offset
		X-axis Field Offset	10	0	0	+75% offset
		X-axis Field Offset	9	0	0	+50% offset
		X-axis Field Offset	10	1	1	+50% offset
		X-axis Field Offset	9	0	1	+25% offset
		X-axis Field Offset	10	0	0	+25% offset
		Y-axis Field Offset	10	0	0	0% offset
		Y-axis Field Offset	11	1	1	0% offset
		Y-axis Field Offset	10	1	1	-25% offset
Y-axis Field Offset	11	0	0	-25% offset		
Y-axis Field Offset	10	0	1	-50% offset		
Y-axis Field Offset	11	0	1	-50% offset		
Y-axis Field Offset	10	1	1	-75% offset		
Y-axis Field Offset	11	1	0	-75% offset		
Y-axis Field Offset	10	0	0	+75% offset		
Y-axis Field Offset	11	0	0	+75% offset		
Y-axis Field Offset	10	0	1	+50% offset		
Y-axis Field Offset	11	0	1	+50% offset		
Y-axis Field Offset	10	0	0	+25% offset		
Y-axis Field Offset	11	1	0	+25% offset		
0	Base Temp	Z-axis Field Offset	12	0	1	0% offset
0	Internal Temp	Z-axis Field Offset	13	1	1	0% offset
		Z-axis Field Offset	12	1	0	-25% offset
		Z-axis Field Offset	13	0	0	-25% offset
		Z-axis Field Offset	12	1	0	-50% offset
		Z-axis Field Offset	13	1	1	-50% offset
		Z-axis Field Offset	12	1	1	-75% offset
		Z-axis Field Offset	13	0	0	-75% offset
		Z-axis Field Offset	12	0	0	+75% offset
		Z-axis Field Offset	13	0	0	+75% offset
		Z-axis Field Offset	12	0	0	+50% offset
		Z-axis Field Offset	13	1	1	+50% offset
		Z-axis Field Offset	12	0	1	+25% offset
		Z-axis Field Offset	13	0	0	+25% offset
		Scientific/Cal Mode	13	0	0	Calibrate ON
		13	1	1	1	Calibrate OFF
		0	Level Sensor 1	Offset Axis Address	14	0
Offset Axis Address	14			1	0	X-axis position
Offset Axis Address	14			0	1	Y-axis position
Offset Axis Address	14			1	1	Z-axis position
0	Level Sensor 2	Filter Status	15	1	0	Filter bypassed
		Filter Status	15	0	0	Filter not bypassed
		Flip/Cal Inhibit Status	15	1	1	Calibration Inhibited
		Flip/Cal Inhibit Status	15	0	0	Calibration not inhibited
0	Supply Voltage 1	Filler Bits	16	0	0	Not used

TABLE 6-XII.- ACTIVE SEISMIC EXPERIMENT MEASUREMENTS LIST, ALSEP 3
(ASE IN OPERATE SELECT, HBR ONLY)

Symbol	Location/Measurement	ASE Word	Subword	Sensor Range
DS-17	ASE Frame Sync	0	1 & 2	PCM 0000111011 binary
DS- 2	Geophone 2 Data	0-31	3	Millimicrons of gnd motion
DS- 3	Geophone 3 Data	0-31	4	Millimicrons of gnd motion
DS- 1	Geophone 1 Data	1 1-31	1 2	Millimicrons of gnd motion
AR- 4	Cld Frame 1 Deg F	2-3	1	400° to 600°F Note 1
DS- 7	ASE Pitch Deg	4-5	1	±10° (arc) Note 1
DS- 5	Mortar Box Gnd V	6-7	1	0 to 5000 mV Note 1
DS- 6	ASE Roll Deg	8-9	1	±10° (arc) Note 1
	Not used	10-11	1	-----
AS- 3	ASE GLA Deg C	12-13	1	-70° to +100°C Note 1
DS- 8	ASE Cal Sig Volts	14-15	1	0 to 5 Vdc Note 1
DS-11	ASE ADC 3.75 Volts	16-17	1	0 to 5 Vdc Note 1
DS-10	ASE ADC 1.25 Volts	18-19	1	0 to 5 Vdc Note 1
AS- 1	ASE Int Fkg Deg C	20-21	1	-70° to 100°C Note 1
AE- 3	PCU In Volts	22-23	1	0 to 20 Vdc Note 1
AE- 4	PCU In Amps	24-25	1	0 to 5 Adc Note 1
AR- 1	Hot Frame 1 Deg F	26-27	1	950° to 1150°F Note 1
DS-18	ASE Mark Event	28	1	PCM 00100 binary Note 2
DS-19	ASE Word Cnt	29	1	PCM 0 - 31 decimal Note 3
DS-20	ASE Event Bit Cnt	30	1	PCM decimal cnts Note 4
DS-13	ASE Mode ID	31	1	PCM decimal cnts Note 5

Note 1: Typical engineering word formats:

ASE Word 2

AR-4					DS-1 DS-2 DS-3
2 ⁷	2 ⁶	2 ⁵	2 ⁴	-	

ASE Word 3

AR-4					DS-1 DS-2 DS-3
2 ³	2 ²	2 ¹	2 ⁰	-	

Note 2: DS-18 - Mark Code = 00100 if real-time event (RTE) occurred in previous frame. Otherwise all zeros.

Note 3: DS-19 - Reads out the word number (in PCM) in previous frame in which an RTE occurred. Otherwise all zeros.

Note 4: DS-20 - Reads out the bit number (in PCM) in the word in which an RTE occurred. Otherwise all zeros.

Note 5: DS-13 - Reads out the mode ID in PCM.

- 0 ON
- 1 ARM GRENADES
- 2 ARM THUMPER
- 4 CALIBRATE GEOPHONES

TABLE 6-XIII.- ACTIVE SEISMIC EXPERIMENT MEASUREMENTS LIST, ALSEP 3

Symbol	Location/Measurement	Range	ASE Mode			
			OPER SEL		STBY SEL	
			HBR off*	HBR on**	HBR off*	HBR on
AS-1	ASE Int Pkg Deg C	-70° to +100° C	---	ASE WD 20-21	CH 25	
AS-2	Mortar Box Deg C	-75° to +100° C	CH 40	---	CH 40	Meaningless
AS-3	ASE GLA Deg C	-70° to +100° C	---	ASE WD 12-13	CH 44	downlink
AS-4	Geophone Deg C	-200° to +130° C	---	---	CH 73	

*Via ALSEP 90-channel analog MUX.

**Via ASE 10.6 kbps downlink.

Heat Flow Word	Bit Position										ALSEP Frames
	1	2	3	4	5	6	7	8	9	10	
0	R ₂	R ₁	0	P ₄	P ₃	P ₂	P ₁	2 ¹²	2 ¹¹	2 ¹⁰	0
	2 ⁹	2 ⁸	2 ⁷	2 ⁶	2 ⁵	2 ⁴	2 ³	2 ²	2 ¹	2 ⁰	1
1	R ₂	R ₁	M ₁	M ₂	M ₃	0	0	2 ¹²	2 ¹¹	2 ¹⁰	2
	2 ⁹	2 ⁸	2 ⁷	2 ⁶	2 ⁵	2 ⁴	2 ³	2 ²	2 ¹	2 ⁰	3
2	R ₂	R ₁	H ₄	H ₃	H ₂	H ₁	0	2 ¹²	2 ¹¹	2 ¹⁰	4
	2 ⁹	2 ⁸	2 ⁷	2 ⁶	2 ⁵	2 ⁴	2 ³	2 ²	2 ¹	2 ⁰	5
3	R ₂	R ₁	0	0	0	0	0	2 ¹²	2 ¹¹	2 ¹⁰	6
	2 ⁹	2 ⁸	2 ⁷	2 ⁶	2 ⁵	2 ⁴	2 ³	2 ²	2 ¹	2 ⁰	7

Notes:

1. It takes two ALSEP main frames to downlink one heat flow word. It takes four heat flow words to obtain one measurement except in Thermocouple Group Probe 1 and 2. In Thermocouple Group Probe 1 and 2 each heat flow word contains a single measurement.
2. Measurement DH-90: M₁, M₂, and M₃ identifies mode.
3. Measurement DH-91: P₄, P₃, P₂, and P₁ are measurement identification in gradient mode and low conductivity mode.
4. Measurement DH-92: R₂ and R₁ are the binary equivalent of heat flow word and identify the analog parameters (13-bits) that are used in the calculation to derive the engineering units for a measurement number.
5. Measurement DH-93: H₄, H₃, H₂, and H₁ identify the conductivity heater status. In the high conductivity mode it identifies the measurement numbers also.
6. Measurement DH-94: Filler bits (shown as zeros in above chart).

Figure 6-6. - HFE word format.

*

TABLE 6-XIV.- HFE MEASUREMENTS, MODE 1 AND 2 GRADIENT AND LOW CONDUCTIVITY

SYMBOL	LOCATION/MEASUREMENT	FRAME	RANGE
DH-1	ΔT_{11} H Temp Grad High Sens	0-7	$\pm 2^{\circ}\text{C}$
DH-2	ΔT_{12} H Temp Grad High Sens	8-15	$\pm 2^{\circ}\text{C}$
DH-3	ΔT_{21} H Temp Grad High Sens	90-97	$\pm 2^{\circ}\text{C}$
DH-4	ΔT_{22} H Temp Grad High Sens	98-105	$\pm 2^{\circ}\text{C}$
DH-5	ΔT_{11} L Temp Grad Low Sens	180-187	$\pm 2^{\circ}\text{C}$
DH-6	ΔT_{12} L Temp Grad Low Sens	188-195	$\pm 2^{\circ}\text{C}$
DH-7	ΔT_{21} L Temp Grad Low Sens	270-277	$\pm 2^{\circ}\text{C}$
DH-8	ΔT_{22} L Temp Grad Low Sens	278-285	$\pm 2^{\circ}\text{C}$
DH-9	T ₁₁ Probe, Ambient Temp	360-367	200 to 250°K
DH-10	T ₁₂ Probe, Ambient Temp	368-375	200 to 250°K
DH-11	T ₂₁ Probe, Ambient Temp	450-457	200 to 250°K
DH-12	T ₂₂ Probe, Ambient Temp	458-465	200 to 250°K
DH-13	Ref T ₁ , Temp Ref Junction	540-547	-20 to +60°K
* DH-14, 24, 34, 44	TC ₁ Group Probe Cable Temp	548-555	90 to 350°K
DH-15	Ref T ₂ , Temp Ref Junction	630-637	-20 to +60°K
* DH-16, 26, 36, 46	TC ₂ Group Probe Cable Temp	638-645	90 to 350°K

*See Table 7-I for these measurements.

TABLE 6-XV.- HFE MEASUREMENTS, MODE 3, HIGH CONDUCTIVITY

SYMBOL	LOCATION/MEASUREMENT	FRAME	RANGE	H-BITS	PROBE	BRIDGE	HEATER STATUS
DH-50	Differential Temp	0-7		0000	1	1	Off
DH-51	Ambient Temp	8-15		0000	1	1	Off
DH-52	Differential Temp	0-7		0001	1	1	H ₁₂ On
DH-53	Ambient Temp	8-15		0001	1	1	H ₁₂ On
DH-60	Differential Temp	0-7		0010	1	2	Off
DH-61	Ambient Temp	8-15		0010	1	2	Off
DH-62	Differential Temp	0-7		0011	1	2	H ₁₄ On
DH-63	Ambient Temp	8-15		0011	1	2	H ₁₄ On
DH-56	Differential Temp	0-7		0100	1	1	Off
DH-57	Ambient Temp	8-15		0100	1	1	Off
DH-58	Differential Temp	0-7		0101	1	1	H ₁₁ On
DH-59	Ambient Temp	8-15		0101	1	1	H ₁₁ On
DH-66	Differential Temp	0-7		0110	1	2	Off
DH-67	Ambient Temp	8-15		0110	1	2	Off
DH-68	Differential Temp	0-7		0111	1	2	H ₁₃ On
DH-69	Ambient Temp	8-15		0111	1	2	H ₁₃ On
DH-70	Differential Temp	0-7		1000	2	1	Off
DH-71	Ambient Temp	8-15		1000	2	1	Off
DH-72	Differential Temp	0-7		1001	2	1	H ₂₂ On
DH-73	Ambient Temp	8-15		1001	2	1	H ₂₂ On
DH-80	Differential Temp	0-7		1010	2	2	Off
DH-81	Ambient Temp	8-15		1010	2	2	Off
DH-82	Differential Temp	0-7		1011	2	2	H ₂₄ On
DH-83	Ambient Temp	8-15		1011	2	2	H ₂₄ On
DH-76	Differential Temp	0-7		1100	2	1	Off
DH-77	Ambient Temp	8-15		1100	2	1	Off
DH-78	Differential Temp	0-7		1101	2	1	H ₂₁ On
DH-79	Ambient Temp	8-15		1101	2	1	H ₂₁ On
DH-86	Differential Temp	0-7		1110	2	2	Off
DH-87	Ambient Temp	8-15		1110	2	2	Off
DH-88	Differential Temp	0-7		1111	2	2	H ₂₃ On
DH-89	Ambient Temp	8-15		1111	2	2	H ₂₃ On

TABLE 6-XVI.- HFE MEASUREMENTS, ANALOG

SYMBOL	LOCATION/MEASUREMENT	CHANNEL	RANGE	DECIMAL PCM
AH-1	Supply Voltage #1	29	0 to +5 Volts	
AH-2	Supply Voltage #2	45	0 to -5 Volts	
AH-3	Supply Voltage #3	55	0 to +15 Volts	
AH-4	Supply Voltage #4	74	0 to -15 Volts	
AH-5	Not Assigned			
AH-6	Low Cond Heater Power Status	57	2 to 2.5 Volts On otherwise Off	102-128 Htr On 3-101 Htr Off
AH-7	High Cond Heater Power Status	75	2 to 2.5 Volts On otherwise Off	102-128 Htr On 3-101 Htr Off

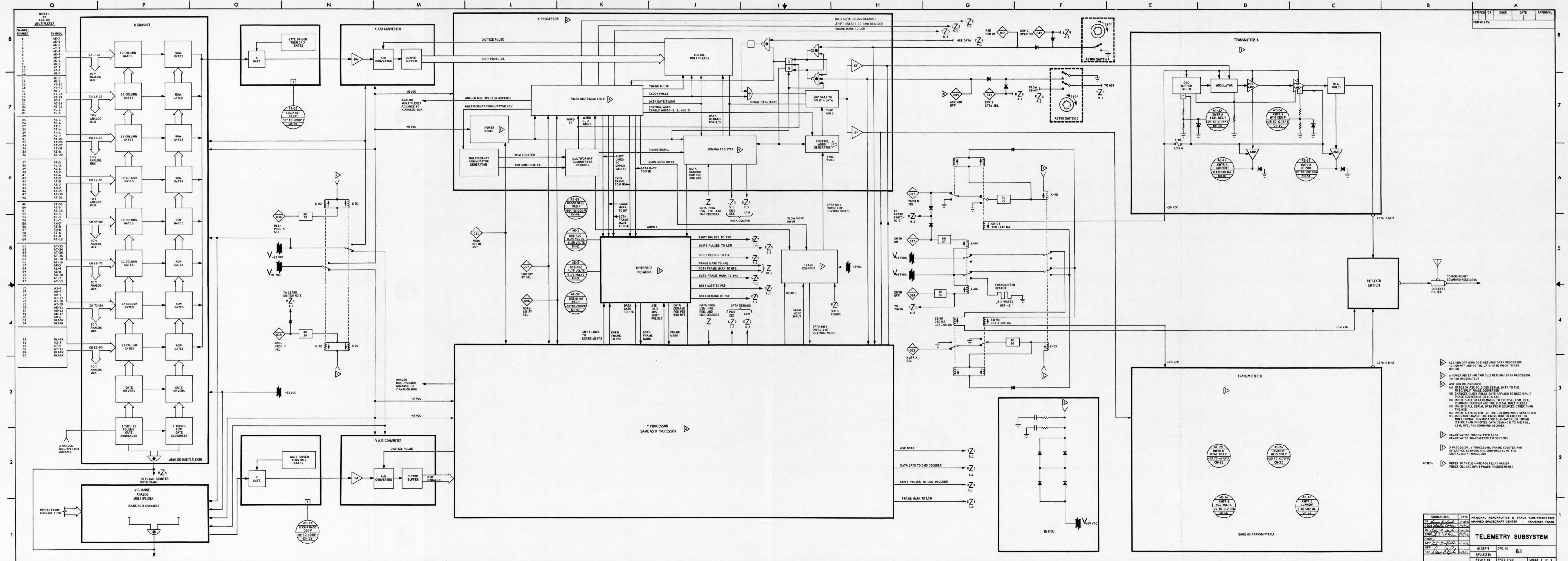

DATE	ENGR	DR	TRN	APPROVAL

- NOTES:
- △ ASE HBR OFF (CMD 005) RETURNS DATA PROCESSOR TO HBR OFF AND TO THE DATA RATE PRIOR TO ASE HBR ON
 - △ A POWER RESET (OR CMD 011) RETURNS DATA PROCESSOR TO HBR IMMEDIATELY
 - △ ASE HBR ON (CMD 003):
 - (A) GATES ON ASE 1.0 & KBS SERIAL DATA TO THE MUX/SPLIT PHASE CONVERTER
 - (B) CHANGES CLOCK PULSE RATE APPLIED TO MUX/SPLIT PHASE CONVERTER TO 1.0 & KBS
 - (C) INHIBITS ALL DATA DEMANDS TO THE PSE, LSM, HFE, COMMAND RECORDER AND THE DIGITAL MULTIPLEXER
 - (D) INHIBITS ALL SERIAL DATA FROM SOURCES OTHER THAN THE ASE
 - (E) INHIBITS THE OUTPUT OF THE CONTROL WORD GENERATOR (F) DOES NOT CHANGE THE TIMING NOR ON LHM TO THE MULTIFORMAT COMMUTATOR GENERATOR, OR TIMING OTHER THAN INHIBITED DATA DEMANDS TO THE PSE, LSM, HFE, AND COMMAND RECORDER
 - △ DEACTIVATING TRANSMITTER ALSO DEACTIVATES TRANSMITTER TM SENSORS
 - △ X PROCESSOR, Y PROCESSOR, FRAME COUNTER AND INTERFACE NETWORK ARE COMPONENTS OF THE DIGITAL DATA PROCESSOR

SIGNATURES	DATE	NATIONAL AERONAUTICS & SPACE ADMINISTRATION
DR	11/17/68	MANNED SPACECRAFT CENTER - HOUSTON, TEXAS
DESIGNED BY	11/17/68	
ENGR	11/17/68	
APP	11/17/68	
STC	11/17/68	

APP	ALSEP 3	DWG NO	6.1
STC	APOLLO 16	93.5 X 34	PAGE 6-23 SHEET 1 OF 1

TELEMETRY SUBSYSTEM

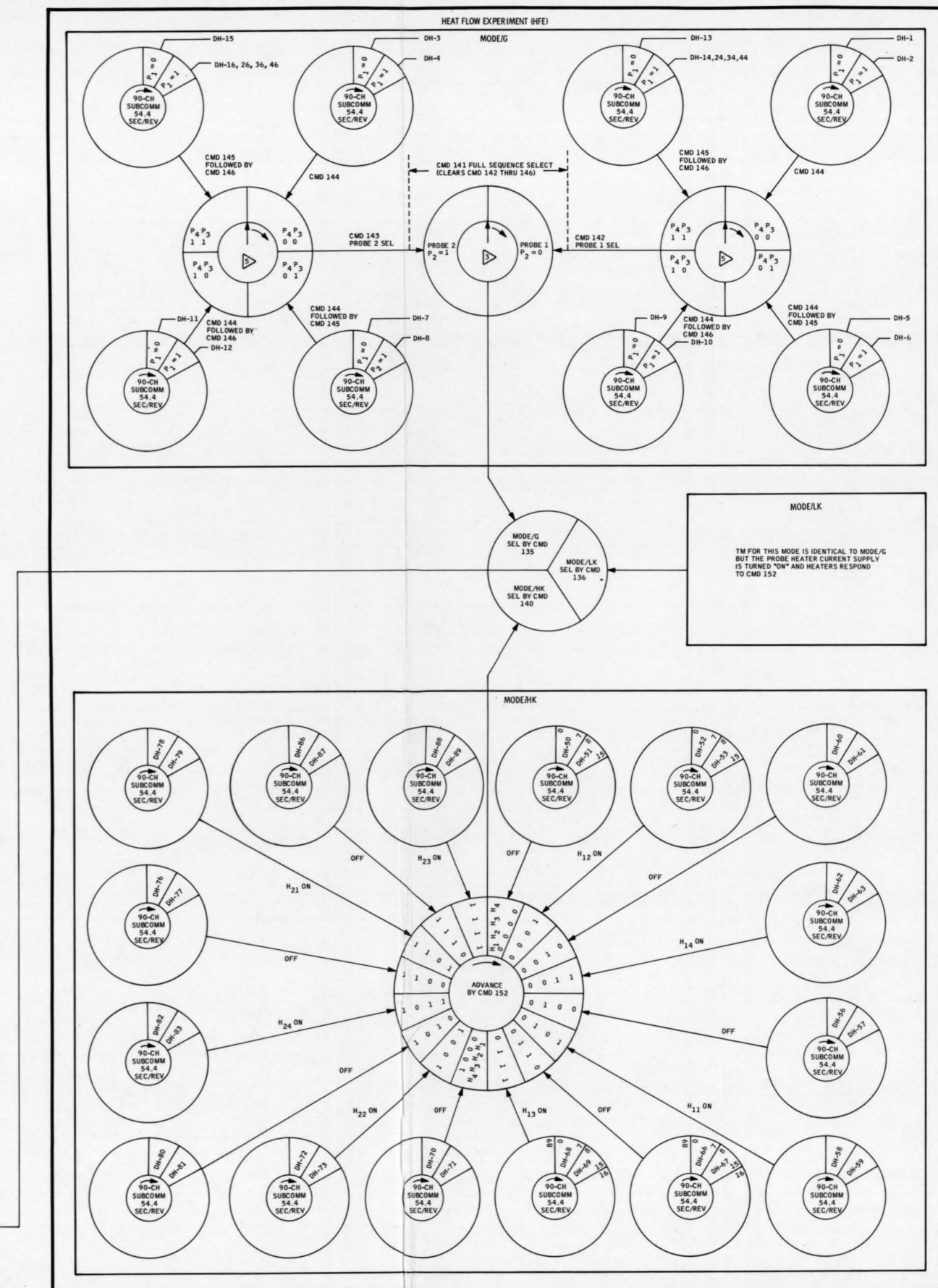
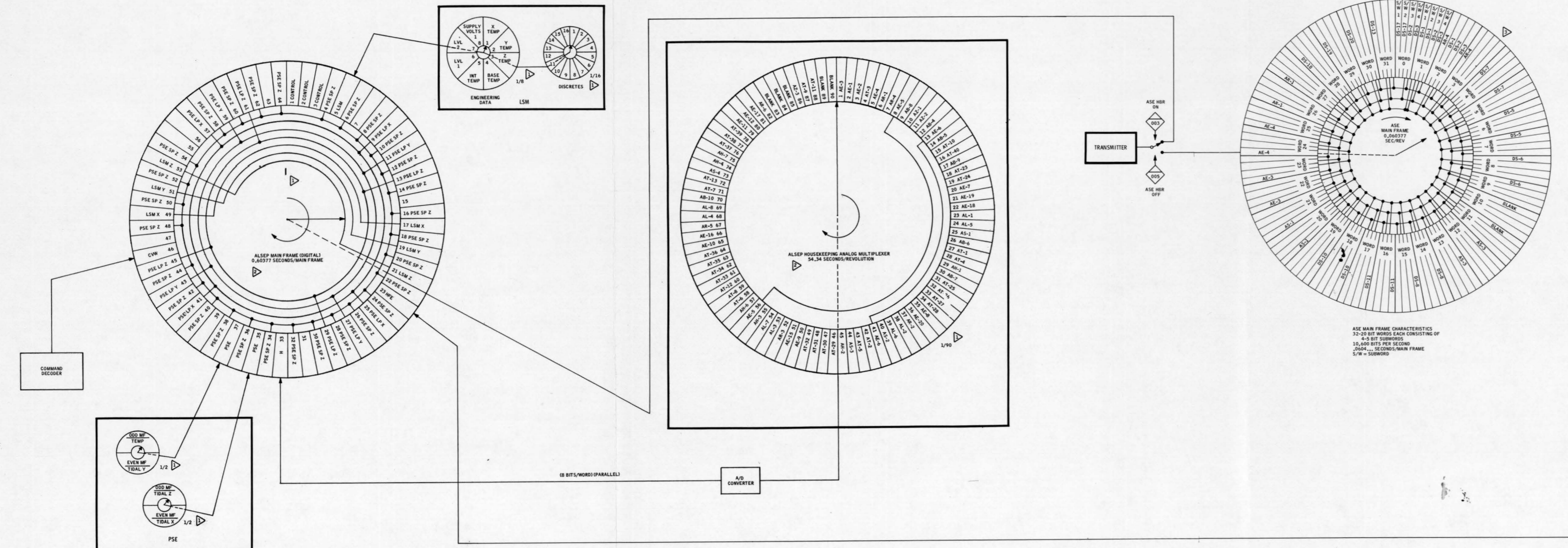

CMD	CMD STATE	SUBCOMM STATE	MEASUREMENT	SUBCOMM RATE	
141	144	0	0	DH-1 THRU 4	100.8
142	144	0	0	DH-1 AND 2	54.4
143	144	0	0	DH-3 AND 4	54.4
141	144	145	0	DH-5 THRU 8	100.8
142	144	145	0	DH-5 AND 6	54.4
143	144	145	0	DH-7 AND 8	54.4
141	144	146	0	DH-9 THRU 12	100.8
142	144	146	1	DH-9 AND 10	54.4
143	144	146	1	DH-11 AND 12	54.4
141	145	146	1	DH-13 AND 15, 14-16, 14-16	100.8
142	145	146	1	DH-13 AND 14, 24, 34, 44	54.4
143	145	146	1	DH-15 AND 16, 26, 36, 46	54.4

- WORDS 3 THRU 31 CONTAIN DS-1, 2, 3, IN S/W 2, 3, AND 4
- WHEN CMD 141 IS EXECUTED, THE SUBCOMMUTATOR RATE IS 434.712 SEC/REV (BOTH PROBES ARE SAMPLED); WHEN CMD 142 IS EXECUTED, THE SUBCOMMUTATOR IS LOCKED IN THE '0' STATE (ONLY PROBE 1 IS BEING SAMPLED); WHEN CMD 143 IS EXECUTED, THE SUBCOMMUTATOR IS LOCKED IN THE '1' STATE (ONLY PROBE 2 IS BEING SAMPLED); THE SUBCOMMUTATOR RATE IS EITHER OF THESE TWO STATES IS 217.356 SEC/REV
- TIMES ARE FOR NORMAL BIT RATE (1000 SPS)
- NUMBERS ARE RELATIONS TO ALSEP MAIN FRAME RATE. EXAMPLE: WHEN THE ALSEP MAIN FRAME COMPLETES ONE REVOLUTION ALSEP HOUSEKEEPING ANALOG MULTIPLEXER TURNS 1/90 OF A REVOLUTION

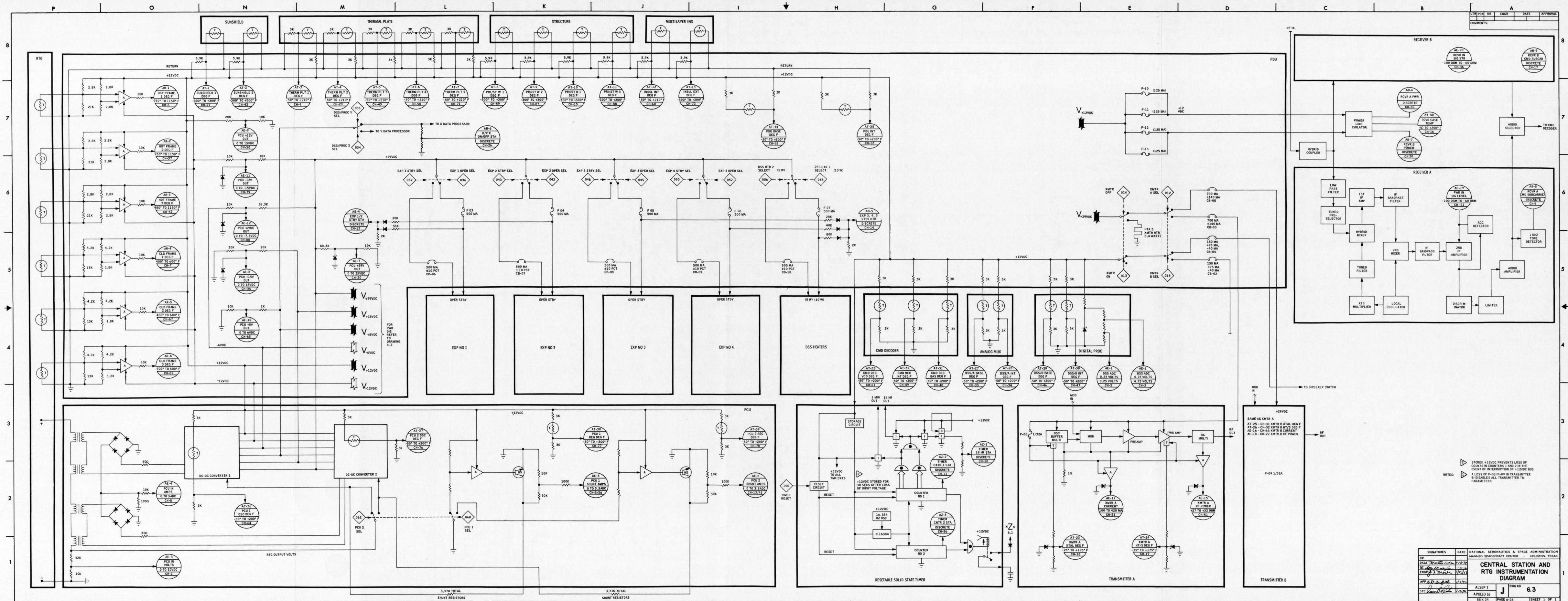

DATE	ENGR	APPROVAL

COMMENTS:

NOTES:
 ▲ STORED +12VDC PREVENTS LOSS OF COUNTS IN COUNTERS 1 AND 2 IN THE EVENT OF INTERRUPTION OF +12VDC BUS
 ▼ A LOSS OF F-08 IF-09 IN TRANSMITTER B DISABLES ALL TRANSMITTER TM PARAMETERS

SIGNATURES	DATE	NATIONAL AERONAUTICS & SPACE ADMINISTRATION MANNED SPACECRAFT CENTER - HOUSTON, TEXAS
DESIGNER: <i>[Signature]</i>	1/12/70	CENTRAL STATION AND RTG INSTRUMENTATION DIAGRAM ALSEP 3 APOLLO 16 88 X 34 PAGE 6-25 SHEET 1 OF 1
ENGINEER: <i>[Signature]</i>	1/12/70	
APP. BY: <i>[Signature]</i>	1/12/70	
STC: <i>[Signature]</i>	1/12/70	

7 PSE (s031)

*

SECTION 7

PASSIVE SEISMIC EXPERIMENT (S031)

7.1 SYSTEM DESCRIPTION

The passive seismic experiment (PSE) provides data on lunar seismic activity and the properties of the lunar interior. The PSE does this by monitoring the long-period, low-frequency and the short-period, high-frequency energy associated with lunar quakes as well as measuring the direction and the distance to the seismic epicenters.

Physically, the PSE consists of two parts, both included in one package. The long-period instrument, which contains three seismometers (one vertical and two horizontal, placed orthogonally to each other), measures long-period, low-frequency seismic energy with a period of 250 to 0.3 seconds. This instrument measures the distance and direction to a seismic quake, as well as the long-term tidal deformations of the moon. The short-period instrument functions as a velocity transducer which measures short-period (5 to 0.04 seconds), high-frequency (up to 25 cycles per second) seismic energy with very high sensitivity. The instrument consists of a moving-magnet mass built so that a transducer can measure the velocity of the magnet. The displacements and the velocity of these instruments are measured, amplified, and filtered in a series of electronic circuits which produce an output signal to the central station data processor.

When the PSE is deployed by the crew, it must be leveled to within ± 5 degrees. Within the instrument case, the seismic elements are mounted on gimbals having leveling motors which can level from an initial tilt as great as 5 degrees. By using a combination of "coarse-level" sensors and the horizontal

ALSEP 3
BASIC

*

seismometers, the PSE can be leveled on command to within 3 arc-seconds.

The PSE will normally be leveled using the auto leveling mode (refer to Table 7-I for the preset conditions) with the forced mode as a backup method. The coarse sensors (utilized only in the X and Y axes) will be commanded in for the initial leveling sequence. The coarse sensors are effective in the auto mode only and provide the X- or Y-axis leveling motor drive signals when there exists an off level condition greater than 8 arc-minutes. At this point the axes' tidal outputs provide the leveling motor drive signals to control leveling to the final level condition.

TABLE 7-I.- PSE PRESET CONDITIONS

["Preset" is defined as the logic condition initialized by activation of the experiment]

Command	Function	Presets to	Lunar deployment condition
037	EXP 1 STBY SEL		Exp in stby
063	PSE/XY GAIN CH	-30 dB	
064	PSE/Z GAIN CH	-30 dB	
065	PSE/SP CAL CH	Off	
066	PSE/LP CAL CH	Off	
067	PSE/SP GAIN CH	-30 dB	
070	LVL MTRX ON/OFF	Off	
071	LVL MTRY ON/OFF	Off	
072	LVL MTRZ ON/OFF	Off	
073	UNCAGE ARM/FIRE	Caged	
074	LVL DIR POS/NEG	Pos	
075	LVL SPEED HI/LO	Low	
076	PSE T CTL CH	Auto on	
101	PSE FILT IN/OUT	Out	
102	LVL SNSR IN/OUT	Out	
103	PSE LVL MDE A/F	Auto	

TABLE 7-II.- PSE LEVELING RATES

Condition	X or Y	Z
Power mode		
High speed	152 to 305 μ rad/sec	20 to 40 mgal/sec
Low speed	5.1 to 17.7 μ rad/sec	0.67 to 2.34 mgal/sec
Automatic mode		
Coarse sensor in (off level >8 arc-min)	152 to 305 μ rad/sec	No coarse sensor on Z-axis. Use forced mode.
Coarse sensor out (tidal output saturated)	3.8 to 7.6 μ rad/sec	0.5 to 1.0 mgal/sec
Coarse sensor out (tidal data unsaturated)	0 to 3.8 μ rad/sec	0 to 1.0 mgal/sec

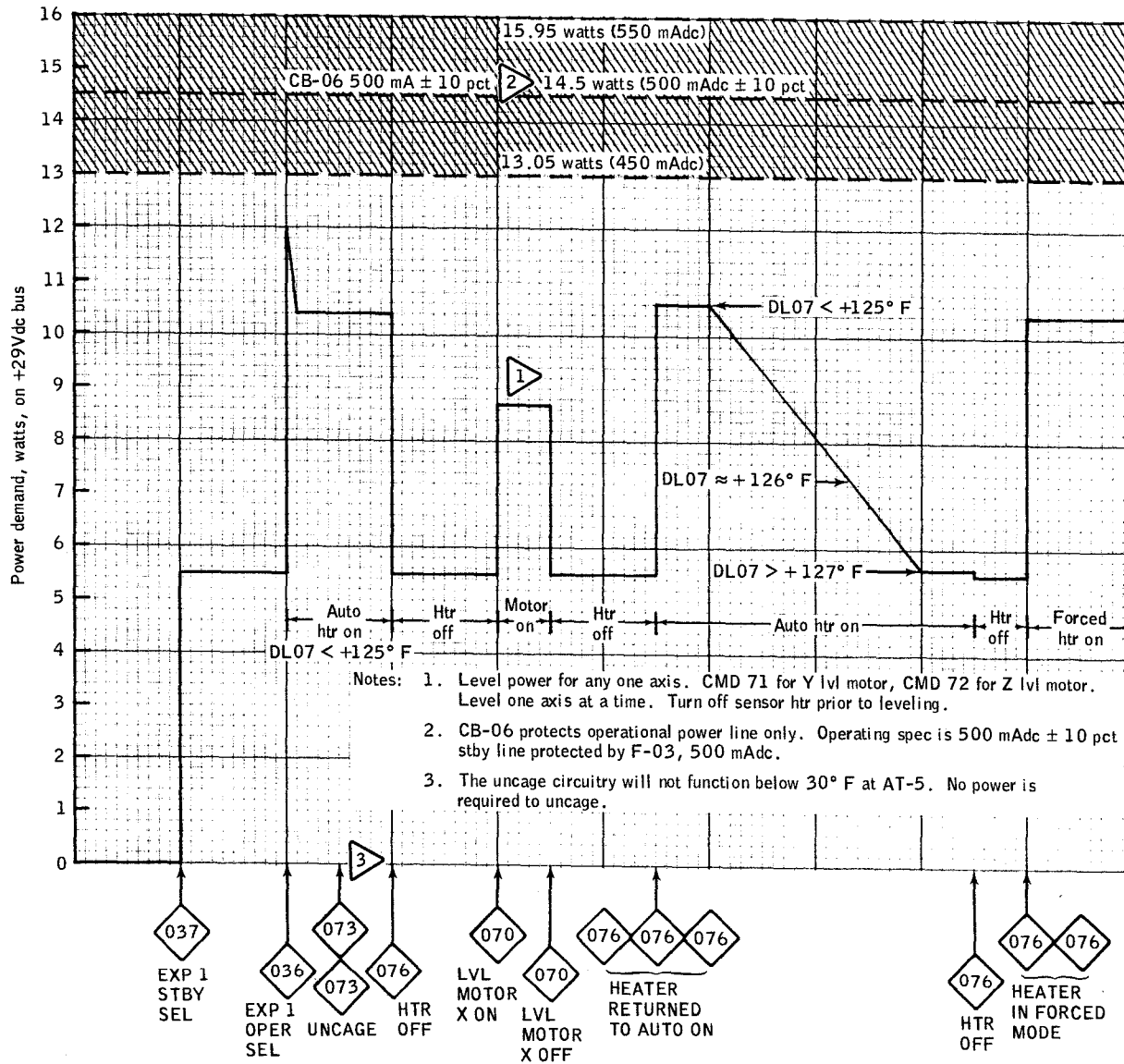
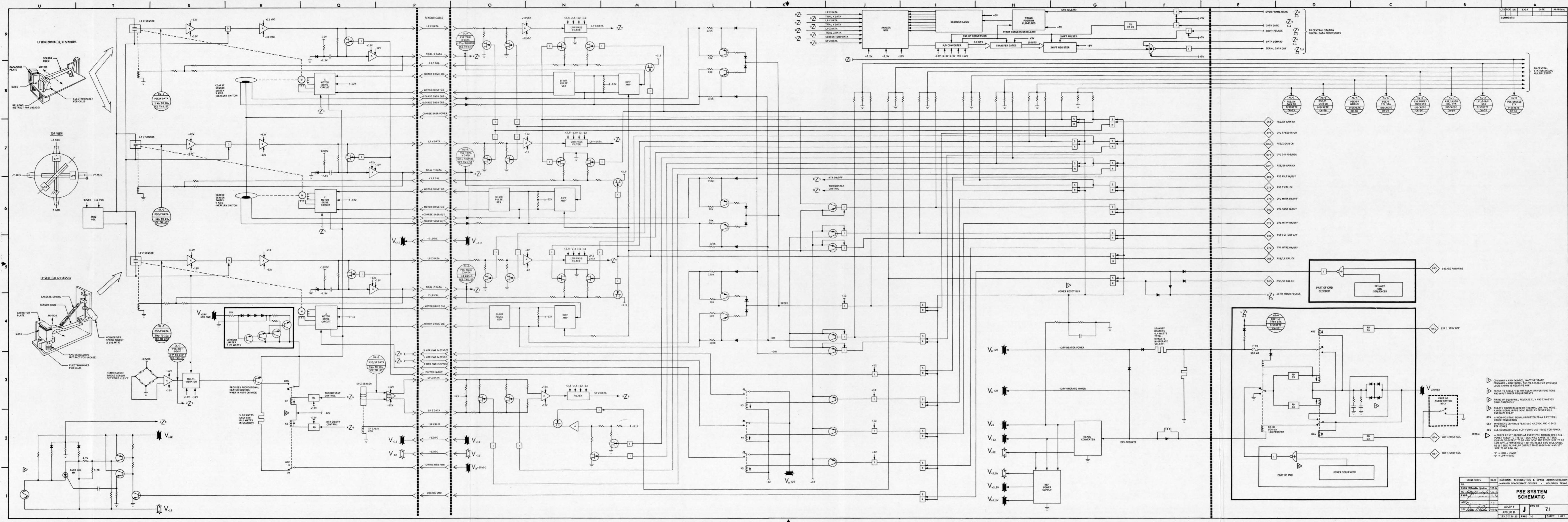

Figure 7-1. - PSE power profile.



- NOTES:**
- COMMAND = HIGH (+5VDC), INACTIVE STATE COMMAND = LOW (0VDC). ACTIVE STATE FOR 20 MSEC LOGIC SHOWN IS NEGATIVE NMR
 - REFER TO TABLE 4-B FOR RELAY DRIVER FUNCTIONS AND INPUT POWER REQUIREMENTS
 - FIRING OF SQUID WILL RELEASE X, Y AND Z MASSES (WINDS AND DROPS)
 - RELAY SQUID IN AUTO ON THERMAL CONTROL MODE. A HIGH SIGNAL INPUT (+5V) TO RELAY DRIVER WILL ENERGIZE RELAY
 - A HIGH (POSITIVE) SIGNAL INPUT TO AN N FET WILL CAUSE CONDUCTION
 - INVERTERS DRIVING N FETS USE +3.2VDC AND -12VDC FOR POWER
 - ALL COMMAND LOGIC FLIP-FLOPS USE +5VDC FOR POWER
 - A POWER RESET OCCURS AT EVERY PSE TURNING OPER SEL. POWER RESET TO THE SET SIDE WILL CAUSE SET SIDE FLIP-FLOP OUTPUT TO GO HIGH (+5V) AND RESET SIDE TO GO LOW (0V). A POWER RESET TO THE RESET SIDE WILL CAUSE RESET SIDE FLIP-FLOP OUTPUT TO GO HIGH (+5V) AND SET SIDE TO GO LOW (0V).
 - *1 = HIGH = +5VDC
*0 = LOW = 0VDC

8 LSM EXP (S034)

SECTION 8

LUNAR SURFACE MAGNETOMETER EXPERIMENT (S034)

8.1 SYSTEM DESCRIPTION

The lunar surface magnetometer (LSM) experiment provides data pertaining to the magnitude and temporal variations of the lunar surface equatorial magnetic field vector. The LSM does this by monitoring both the dc level and time variations of the magnetic field.

Physically, the LSM consists of three magnetic sensors, each mounted in a sensor head located at the end of three mutually perpendicular axes. The sensor electronics assembly converts the incident magnetic field intensity along the axes of the respective flux gate sensors into analog voltages. The axes extend equal distances above a central structure, the electronics/gimbal-flip unit (EGFU), which houses both the experiment electronics and the gimbal-flip unit. The experiment electronics and the gimbal-flip unit. The experiment electronics are further subdivided into three functional categories: scientific data processing, engineering and status data processing, and output data buffer (see Drawing 8.3). The gimbal-flip unit houses the flipper drive motors which provide the motive power for 90 and 180-degree rotation (flipping) of the sensors and the release mechanism for the spring-driven 90-degree rotation (gimbaling) of the sensor axes. Instrument support and stability is achieved via three lunar support legs attached to the EGFU.

When the LSM is deployed by the crew, it must be leveled to within ± 3 degrees. No command capability exists in the LSM for leveling.

The temperature of the magnetic sensors is monitored and provided as data output. The LSM heaters actuation temperature is 35° C (95° F).

*

8.2 FLIP-CALIBRATION SEQUENCE (See Drawing 8.1)

The purpose of the flip-cal sequence is to prevent permanent magnetization of the sensors due to lunar magnetic fields. The flip-cal sequence further inserts calibration rasters of known levels to provide baseline data with which to compare lunar magnetic fields.

The flip-cal sequence can be initiated by Ground Command 131 (FLIP/CAL GO), or by an automatically generated command via the ALSEP timer at the ninth 18-hour pulse plus 1 minute and every 18 hours thereafter.

The flip-cal sequence can be inhibited by means of Ground Command 127 (FLIP/CAL INHIB), which prevents the initiation of the flip-cal sequence from either ground command or ALSEP timer-generated command.

The sequence, once initiated, is completely controlled by the LSM flip-cal programmer and cannot be terminated by ground command. The sequence is completed in approximately 350 seconds.

The programmer causes all necessary events to occur in the following order:

- A. Upon receipt of the flip-cal command, two calibration rasters are applied to all sensors (X, Y, and Z) simultaneously for 160 seconds (refer to Drawing 8.1).
- B. The programmer then flips all sensors sequentially 180 degrees and applies reverse field offset bias to each sensor.
- C. Upon completion of the flip action of the three sensors (30 seconds total, 10 seconds per sensor), the programmer applies two more calibration rasters to all three sensors simultaneously for 160 seconds.

GAMMA RANGE	SENSOR POSITION	% OFFSET									
		0	+25	+50	+75	-75	-50	-25			
50	0° OR 90°	+50	+62.5	+75	+87.5	+100	+112.5	+125	+137.5	+150	+162.5
	180°	-50	-62.5	-75	-87.5	-100	-112.5	-125	-137.5	-150	-162.5
100	0° OR 90°	+100	+125	+150	+175	+200	+225	+250	+275	+300	+325
	180°	-100	-125	-150	-175	-200	-225	-250	-275	-300	-325
200	0° OR 90°	+200	+250	+300	+350	+400	+450	+500	+550	+600	+650
	180°	-200	-250	-300	-350	-400	-450	-500	-550	-600	-650

LSM EFFECTIVE RANGES AS A FUNCTION OF OFFSET AND SENSOR POSITION

SENSOR POSITION			
DM-9	DM-10	DM-11	Z
X	Y	Z	
01 (0°)	✓	✓	✓
10 (90°)			
00 (FAIL)			

SENSOR POSITION			
DM-9	DM-10	DM-11	Z
X	Y	Z	
01 (0°)		✓	✓
10 (90°)			
11 (180°)	✓	✓	✓
00 (FAIL)			

SENSOR POSITION			
DM-9	DM-10	DM-11	Z
X	Y	Z	
01 (0°)		✓	✓
10 (90°)			
11 (180°)	✓	✓	✓
00 (FAIL)			

SENSOR POSITION			
DM-9	DM-10	DM-11	Z
X	Y	Z	
01 (0°)		✓	✓
10 (90°)			
11 (180°)	✓	✓	✓
00 (FAIL)			

SENSOR POSITION			
DM-9	DM-10	DM-11	Z
X	Y	Z	
01 (0°)		✓	✓
10 (90°)			
11 (180°)	✓	✓	✓
00 (FAIL)			

SCIENTIFIC ORIENTATION AFTER FLIP CAL SEQ NO 1 (180 DEGREES)

SENSOR POSITION			
DM-9	DM-10	DM-11	Z
X	Y	Z	
01 (0°)	✓	✓	✓
10 (90°)			
11 (180°)	✓	✓	✓
00 (FAIL)			

SCIENTIFIC ORIENTATION AFTER FLIP CAL SEQ NO 2 (0 DEGREES)

SENSOR POSITION			
DM-9	DM-10	DM-11	Z
X	Y	Z	
01 (0°)	✓	✓	✓
10 (90°)			
11 (180°)	✓	✓	✓
00 (FAIL)			

SCIENTIFIC ORIENTATION AFTER FLIP CAL SEQ NO 3 (180 DEGREES)

SENSOR POSITION			
DM-9	DM-10	DM-11	Z
X	Y	Z	
01 (0°)	✓	✓	✓
10 (90°)			
11 (180°)	✓	✓	✓
00 (FAIL)			

SCIENTIFIC ORIENTATION AFTER FLIP CAL SEQ NO 4 (0 DEGREES)

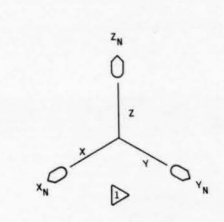

INITIAL SCIENTIFIC ORIENTATION (0 DEGREES)

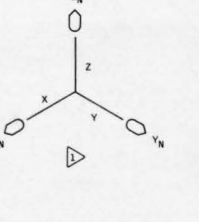
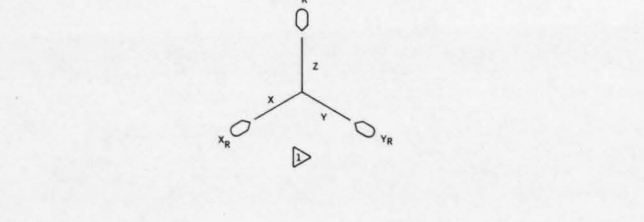
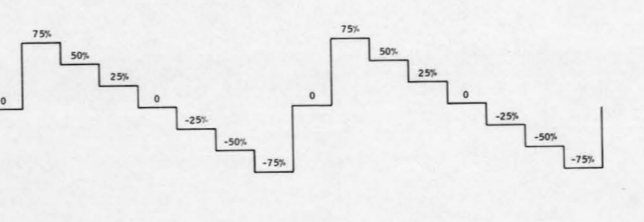
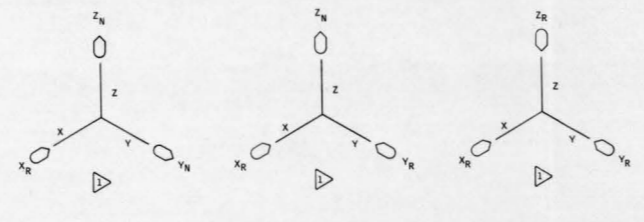
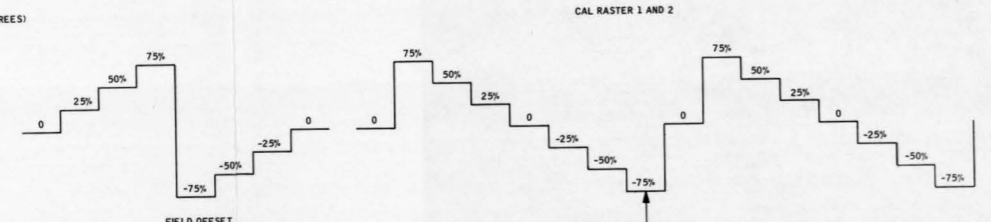

READY FOR X-AXIS SITE SURVEY

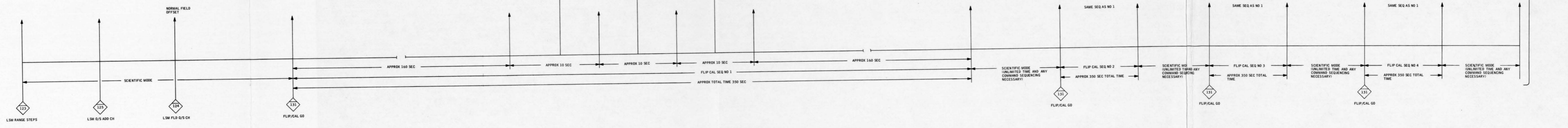

NOTE:
 X_N = X AXIS FIELD OFFSET NORMAL
 X_R = X AXIS FIELD OFFSET REVERSED
 Y_N = Y AXIS FIELD OFFSET NORMAL
 Y_R = Y AXIS FIELD OFFSET REVERSED
 Z_N = Z AXIS FIELD OFFSET NORMAL
 Z_R = Z AXIS FIELD OFFSET REVERSED

*
D. Following the last calibration raster, the programmer stops the flip-cal sequence generator, at which time the LSM is in the normal scientific mode.

The result of the flip-cal sequence is that the sensors are now oriented diametrically opposite in direction, with field offset bias of opposite polarity to that prior to the initiation of the flip-cal sequence.
*

*

8.3 SITE-SURVEY SEQUENCE (Refer to Drawing 8.2)

The site-survey sequence is performed upon completion of the first four flip-cal sequences and will be performed only once during the life of the instrument. The purpose of the site-survey sequence is to measure local accretions of nickel-iron or stony-iron meteoric debris.

8.3.1 X-Axis Site Survey Sequence

Initiation of Ground Command 133 (SITE SURVEY XYZ) simultaneously applies power to the site-survey programmer and to the flip-cal programmer. Once the sequence is initiated, it cannot be terminated by ground command. The site-survey is completed in approximately 630 seconds.

Upon receipt of the site-survey command, the programmer is sequenced to an idle state. The programmer then sequences the sensors through a normal flip-cal sequence. Upon completion of the flip-cal sequence, the programmer flips all sensors sequentially so that they are surveying the X-axis and applies the X field offset bias to each sensor. On completion of the flip action, the programmer places the instrument into X site survey state. Upon completion of site survey, the programmer sequentially flips all sensors back to the previous position and reverses and reinstates the previous field offset bias to each sensor.

8.3.2 Y-Axis Site Survey Sequence

Upon initiation by Ground Command 133, power is simultaneously applied to both the site survey and flip-cal programmers. Site survey cannot be terminated by ground command and completes its sequence in approximately 710 seconds.

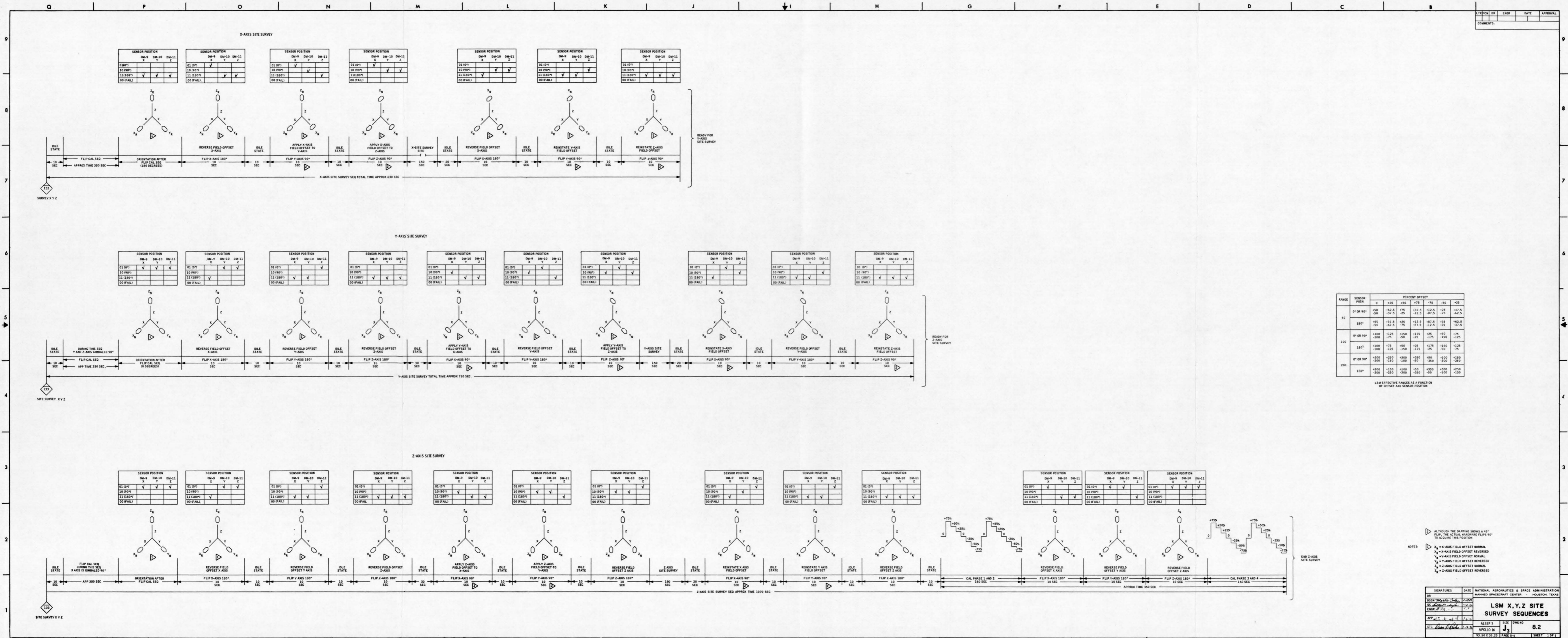

RANGE	SENSOR POSN	PERCENT OFFSET						
		0	+25	+50	+75	-75	-50	-25
50	0° OR 90°	+50	+62.5	+75	+87.5	+12.5	+25	+37.5
	180°	+50	+37.5	+25	+12.5	+87.5	+75	+62.5
100	0° OR 90°	+100	+125	+150	+175	+25	+50	+75
	180°	+100	+75	+50	+25	+175	+150	+125
200	0° OR 90°	+200	+250	+300	+350	+50	+100	+150
	180°	+200	+150	+100	+50	+350	+300	+250

LSM EFFECTIVE RANGES AS A FUNCTION OF OFFSET AND SENSOR POSITION

NOTES:
 1. ALTHOUGH THE DRAWING SHOWS A 45° FLIP, THE ACTUAL MANIPULATOR FLIPS 90° TO ACQUIRE THIS POSITION.
 2. X_n = X-AXIS FIELD OFFSET NORMAL
 3. Y_n = Y-AXIS FIELD OFFSET REVERSED
 4. Z_n = Z-AXIS FIELD OFFSET REVERSED
 5. X_r = X-AXIS FIELD OFFSET REVERSED
 6. Y_r = Y-AXIS FIELD OFFSET NORMAL
 7. Z_r = Z-AXIS FIELD OFFSET NORMAL

*

On receipt of the command, the programer is sequenced to an idle state. The programer then sequences the sensors through a normal flip-cal sequence, with one exception: during the flip-cal sequence the Y- and Z-axis sensor assemblies are gimbaled (90-degree longitudinal rotation). Upon completion of the flip-cal sequence, the programer flips all sensors sequentially 180 degrees and applies reverse field offset bias to each sensor. After completion of the 180-degree flip action, the programer flips all sensors sequentially so that they are surveying the Y-axis and applies the Y field offset bias to each sensor. On completion of the flip action, the programer places the instrument into Y site survey state. Upon completion of site survey, the programer sequentially flips all sensors back to the previous position and reverses and reinstates the previous field offset bias to each sensor.

8.3.3. Z-Axis Site Survey Sequence

Initiation by Ground Command 133 is identical to the previous site survey initiations. The Z-axis site survey completes its sequence in 1070 seconds. Upon receipt of the site-survey command, the programer is sequenced to an idle state. The programer then sequences the sensors through a normal flip-cal sequence, with one exception: during the flip-cal sequence the X-axis sensor assembly is gimbaled (90-degree longitudinal rotation). Upon completion of the flip-cal sequence, the programer flips all sensors sequentially 180 degrees and applies reverse field offset bias to each sensor. On completion of the 180-degree flip action, the programer again flips all sensors sequentially so that they are surveying the Z-axis and applies the Z field offset bias to each sensor. On completion of the flip action, the programer places the instrument into Z site survey state. Upon

*

ALSEP 3
BASIC

completion of site survey, the programmer sequentially flips all sensors back to the previous position and reverses and reinstates the previous field offset bias to each axis. On completion of sensor reinstatement two calibration rasters are applied to all sensors simultaneously. The programmer then flips all sensors sequentially 180 degrees and applies reverse field offset bias to each sensor. The programmer then flips all sensors (X, Y, and Z) simultaneously 180 degrees and applies simultaneously reverse field offset bias to each sensor. Upon completion of the flip action of the three sensors, the programmer applies two more calibration rasters to all three sensors simultaneously. Following the last calibration raster, the programmer stops the site-survey sequence, at which time the LSM is in the normal scientific mode.

TABLE 8-I.- LSM PRESET CONDITIONS

["Preset" is defined as the initialized logic condition due to activation of the LSM experiment]

Command	Function	Presets to	Lunar deployment condition
043	EXP 2 STBY SEL		Exp in stby
123	LSM RANGE STEPS	±200 gamma	
124	LSM FLD O/S CH	0 percent	
125	LSM O/S ADD CH	Neutral	
127	FLIP/CAL INHIB	Inhibit	
131	FLIP/CAL GO	No-go	
132	LSM FILT IN/OUT	In	
133	SITE SURVEY XYZ	No-go	
134	LSM T CTL XYO	X	

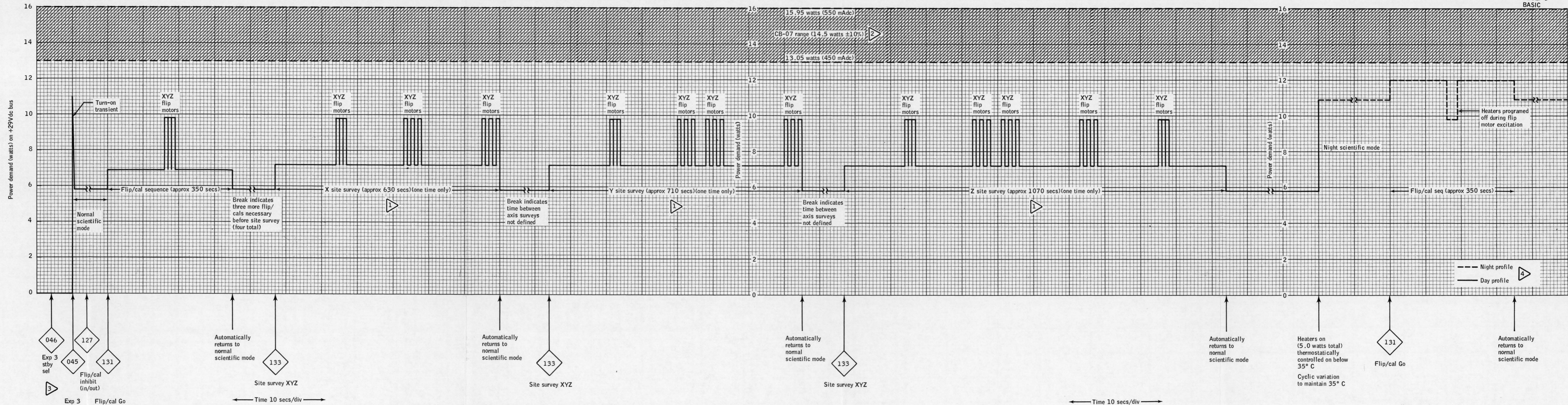

046 Exp 3 stby sel
 127 Exp 3 oper sel
 045 Flip/cal inhibit (in/out)
 131 Flip/cal Go

Automatically returns to normal scientific mode

133 Site survey XYZ

Automatically returns to normal scientific mode

133 Site survey XYZ

Automatically returns to normal scientific mode

133 Site survey XYZ

Automatically returns to normal scientific mode

Heaters on (5.0 watts total) thermostatically controlled on below 35° C
 Cyclic variation to maintain 35° C

131 Flip/cal Go

Automatically returns to normal scientific mode

- Notes:
- 1 Site survey performed one time, during lunar day
 - 2 CB-07 protects operational power line. Operating spec is 500 mA ±10%
 - 3 LSM has no standby power demand
 - 4 Temperature assumed to be above +35° C. If below, add 5 watts for heater power. Heaters automatically programmed off during flip motor on time

Figure 8-1.- LSM power profile.

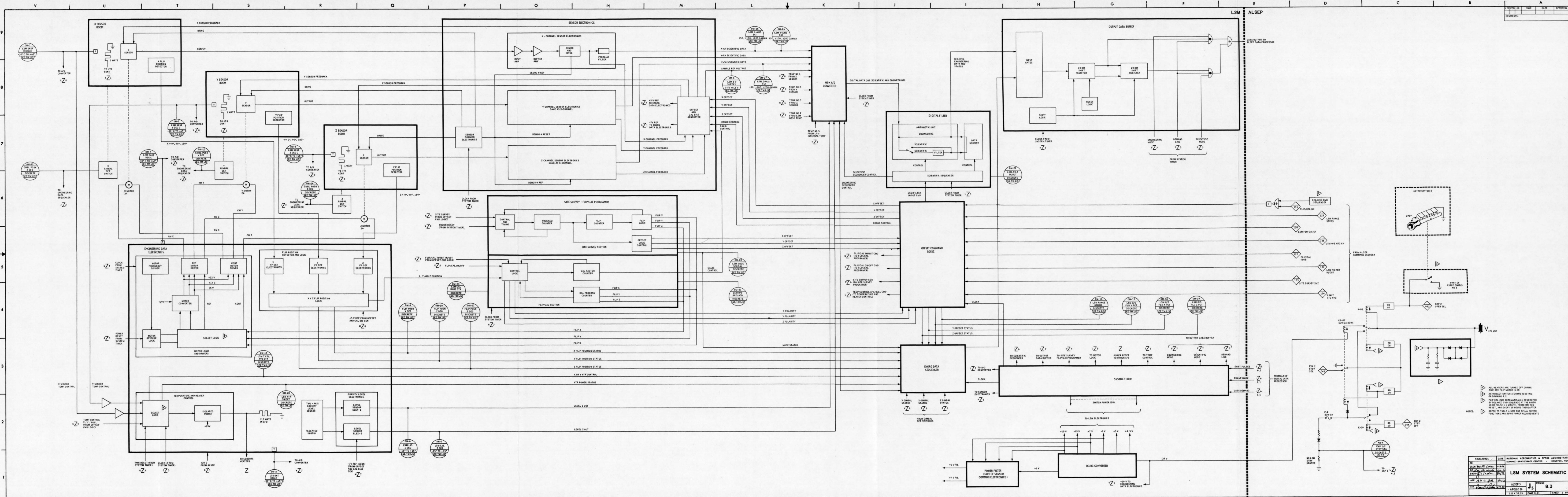

REVISION	DATE	APPROVAL
1	APR 16 1968	J.S.

LSM SYSTEM SCHEMATIC

DATE: APR 16 1968
 DRAWN BY: J.S.
 CHECKED BY: [Signature]
 APPROVED BY: [Signature]

NATIONAL AERONAUTICS & SPACE ADMINISTRATION
 MANNED SPACECRAFT CENTER - HOUSTON, TEXAS

121 X 20 20 PAGE 2-11 SHEET 1 OF 1

NOTES:

- ALL HEATERS ARE TURNED OFF DURING TIME ANY FLIP MOTOR IS ON.
- ASTRONAUT SWITCH 3 SHOWN IN DETAIL ON DRAWING 4.2.
- FLIP CAL CMD AUTOMATICALLY GENERATED BY DELAYED CMD SEQUENCE AT THE WITH 1.8 SEC DELAY - 1.1 MINUTE FROM CMD DELAY. AND EVERY 18 HOURS THEREAFTER. REFER TO TABLE 4-4 FOR RELAY DRIVER FUNCTIONS AND INPUT POWER REQUIREMENTS.

9 ASE (5033)

*

SECTION 9

ACTIVE SEISMIC EXPERIMENT (S033)

9.1 SYSTEM DESCRIPTION

9.1.1 Experiment Objectives

The primary function of the active seismic experiment (ASE) is to generate and monitor artificial seismic waves in the 3- to 250-Hz range in the lunar surface and near subsurface. The ASE can also be used to monitor natural seismic waves in the same frequency range. The objective of these functions is to acquire information to enable determination of the physical properties of lunar surface and near subsurface materials.

9.1.2 Method of Operation

Seismic waves are artificially produced by explosive devices and detected by geophones. By varying the location and magnitude of the explosions with respect to the geophones, penetration of the seismic waves to depths of approximately 500 feet can be achieved, and wave velocities through several layers of subsurface materials can be investigated.

9.1.3 Major Components

Two seismic energy sources are employed. A thumper device containing 21 explosive initiators will be fired along the geophone lines by the astronaut. Two ASI's (numbers 20 and 21) will be test fired at KSC prior to stowage for flight. The astronaut will also emplace a mortar package containing four high-explosive grenades. The grenades will be rocket-launched by RTC's sometime after LM ascent and are designed to impact at four different ranges (approximately 500, 1000, 3000, and 5000 feet) with individual high-explosive charges proportional to their range.

*

The seismic detectors are three identical geophones. The geophones are electromagnetic transducers which translate high-frequency, seismic energy into electrical signals.

9.1.4 Commands and Telemetry

The ASE uses seven commands to arm and fire the grenades and to effect geophone calibration. Other commands are used to effect power distribution to the ASE from the data subsystem and to place the data subsystem in the active seismic mode. The three channels of seismic data generated by the ASE and 16 channels of engineering data will be converted to digital form within the experiment. A 20-bit digital word format and a 10,600 bit/sec data rate will be used in the ASE to insure accurate encoding and transmission of critical, real-time-event data and to provide a data handling capability for high-frequency, seismic data. The higher bit rate and longer word length are incompatible with the normal ALSEP format and preclude usual data collection from the other experiments during the time the ASE is activated.

9.2 FUNCTIONAL DESCRIPTION

The ASE comprises the thumper and geophone assembly, mortar package, central electronics assembly, and interconnecting cabling. Figure 9-1 illustrates the ASE components.

9.2.1 Thumper Assembly

The thumper comprises a short handle or staff with an initiator mounting plate and a base placed at the lower end. The upper end contains a pair of switches (arming/firing, and ASI selection) and associated electronics. A flat, four-conductor cable connects the thumper to the central station. The thumper contains 21 Apollo standard initiators (ASI's). These initiators

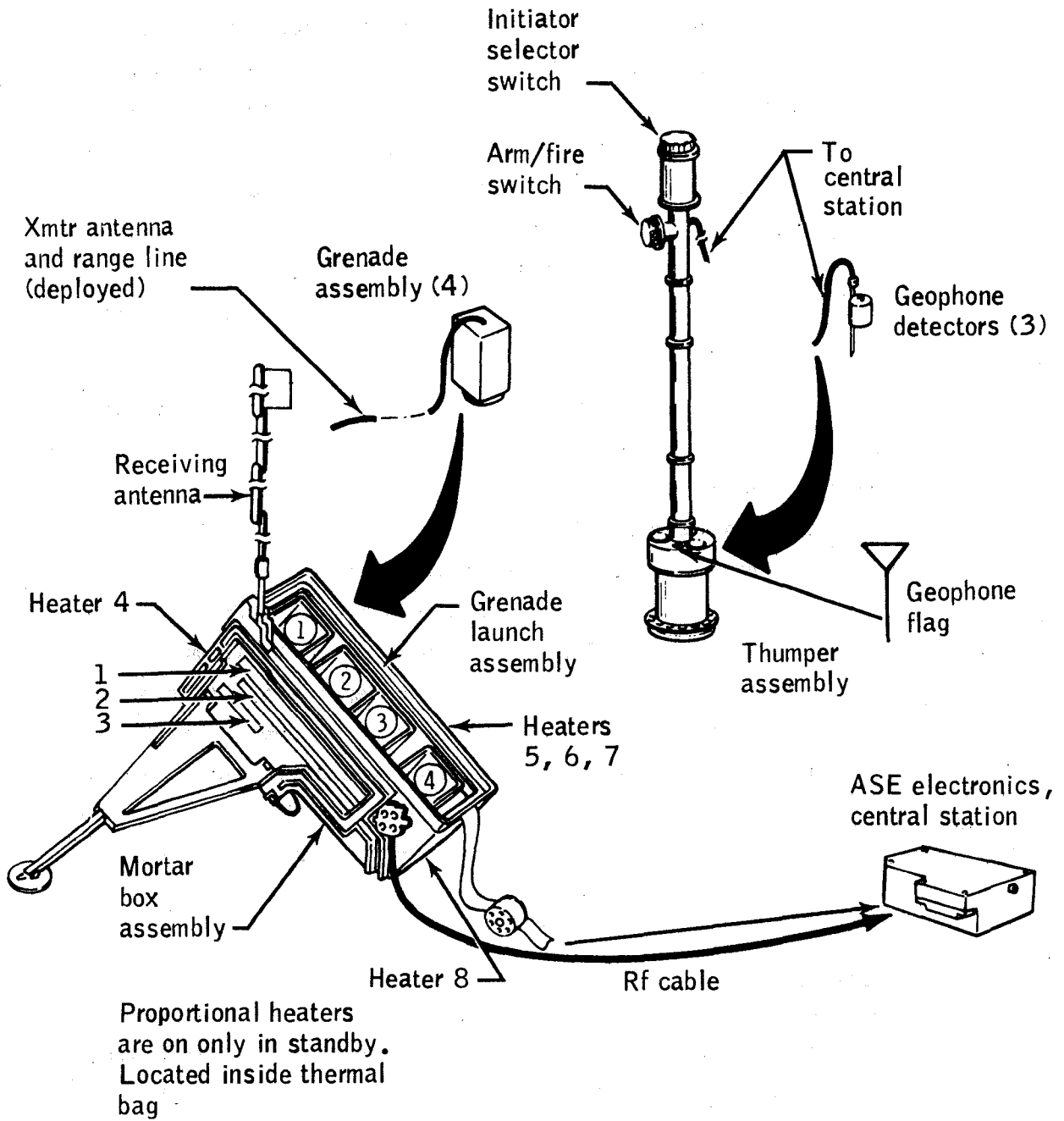

Figure 9-1. - ASE major components.

*
are threaded into a mounting plate which forms a portion of the thumper base (Figure 9-1). The ASI's are individually fired directly into an impact plate which is spring-loaded against the mounting plate. The gas pressure resulting from an initiator explosion drives the impact plate sharply downward, imparting a small blow to the adjacent surface. The gases are immediately vented around the edges of the impact plate and deflected downward by a ring which is part of the mounting plate.

Operation of the thumper requires three distinct mechanical actions through the manipulation of two controls. The ASI selector, a 22-position switch located at the top of the thumper, must be rotated from the no-connection position to a particular position for the selection of one of the 21 initiators. Next, the spring-loaded arm/fire knob, located at the end of the staff arm near the top of the thumper, must be rotated clockwise approximately 40 degrees to its stop and held in this position for a minimum of 4 seconds. Then, without releasing the arm/fire knob, it must be pushed about one-half inch to fire the selected ASI. A pressure switch is actuated at the time of the ASI firing and applies a real-time-event (RTE) mark to the downlink.

9.2.2 Geophones

The three identical geophones are electromagnetic devices which translate physical surface or subsurface movement into electrical signals. The amplitude of the output signals is proportional to the rate of physical motion. The geophones will be deployed at 10, 160, and 310 foot intervals from the central station and are connected to it by cables. The cables and geophones are stored on the thumper during transport and removed during deployment. Geophone No. 1 temperature is downlinked only when the ASE is in STANDBY SELECT.

*
9.2.3 Mortar Package

The mortar package assembly consists of a mortar box assembly, a grenade launch assembly (GLA), and interconnecting cables.

9.2.3.1 Mortar box.- The mortar box is a rectangular Fiberglas box in which the GLA is mounted. The mortar box contains the electronics, a receiving antenna, two safety switches, and a thermal bag. The electronics contain circuitry for the arming and firing of the rocket motors launching four grenades and also for the operation of the heaters. The receiver antenna is a vertical antenna mounted to the side of the mortar box. The antenna is folded along the edge of the package during transport and unfolded by the astronaut during deployment. The arm/fire safety switches disable both arm and firing circuits. The proportional heaters attached to the inside of the thermal bag are activated only in the standby mode of operation. The mortar box temperature is downlinked via the ALSEP 90-channel multiplexer only when the ASE is in STANDBY SELECT.

9.2.3.2 Grenade launch assembly.- The GLA consists of a Fiberglas launch tube assembly which includes the four rocket-launched grenades, a grenade safety release assembly, three micro-switches, three temperature sensors, and a two-axis inclinometer. Each grenade is attached to a range line which is a thin, stranded cable that is wound around the outside of the launch tube. Two fine copper wires are looped around each range line. The first loop is spaced so that it will break when the grenade is about 10 inches out of the launch tube. The second loop is spaced so that it will break when the range line has deployed exactly an additional 25 feet from the first breakwire. Breaking the loops starts and stops a range gate pulse

*

establishing a time interval for determination of the grenade velocity.

The four grenades are similar, differing only in the amount of propellant and high explosive. (Refer to Table 9-I.) The casing contains the rocket motor, safe slide plate, high-explosive charge, ignition and detonation devices, thermal battery, and a 30-MHz transmitter. The range line is attached to the transmitter output and serves as a half-wave, end-feed antenna.

The grenade safety release assembly prevents inadvertent launching of any grenades.

The launch tubes for grenades two, three, and four each contain a microswitch closed by launching the grenade. Each switch connects the firing command from a sequential grenade firing circuit to the next grenade to be launched.

Two temperature sensors are located between tubes one and two, and a third is located between tubes three and four. One of the sensors provides an analog signal of the GLA temperature to the data handling function of the ASE (when in ASE OPERATE SELECT), or to the ALSEP 90-channel multiplexer when in ASE STANDBY SELECT. The other two sensors are part of the heater control circuitry.

9.2.4 ASE Central (Station) Electronics

The central electronics assembly is located in the central station and contains circuits for power control, temperature sensing, calibration, signal conditioning, and data handling. Included as subassemblies are the geophone amplifier, the ASE receiver, and the A/D converter and multiplexer. (Refer to Drawing 9.1.)

TABLE 9-I.- ASE GRENADE CHARACTERISTICS

Grenade number*	Range, ft	Propellant weight, lb	Explosive weight, lb	Initial velocity, ft/sec**	Time to impact, sec**	ΔT 0-25 ft, msec**
1	5000	0.10	1.0	163.2	43.4	153.0
2	3000	0.07	0.6	126.2	33.5	198.0
3	1000	0.03	0.3	73.0	19.4	342.0
4	500	0.01	0.1	51.6	13.7	485.0

*Sequential firing order: 2 - 4 - 3 - 1.

**Computed values based on 5.32 ft/sec^2 gravitational constant and mortar package level with a grenade launch angle of 45° from horizontal.

*

- 9.2.4.1 Power control.- Operating power is supplied from the ALSEP electrical power subsystem at +5 V, +15 V, -12 V, and +29 V (refer to Drawings 4.2 and 9.1). RTC's provide the means to control the ASE to OPERATE SELECT, STANDBY SELECT, or STANDBY OFF. Overloading the +29 Vdc operate bus will cause CB-07 (500 mA \pm 10%) to transfer the ASE to STANDBY SELECT. The +5, +15, and -12 volt buses are protected by circuit breakers CB-11 (500 mA), CB-12 (150 mA), and CB-13 (150 mA), and actuation will not transfer the ASE to STANDBY SELECT. Resetting of CB-11, CB-12, and/or CB-13 can only be accomplished by placing the ASE to STANDBY SELECT.
- 9.2.4.2 Temperature sensing.- There is one temperature sensor located in the ASE central electronics to provide temperature data in both the ASE OPERATE SELECT and ASE STANDBY SELECT modes. Circuitry also exists to provide temperature data in the mortar box, grenade launcher assembly, and one geophone.
- 9.2.4.3 Calibration.- The calibration system is activated by a geophone calibrate command applied to the command gating from the central data subsystem. The calibrate command is gated to the calibration circuitry where it is developed into a 1-second-wide pulse and applied to the calibrate driver, electrically exciting the geophones. A geophone calibrate pulse is also applied to the data handling system from the calibrate driver indicating receipt of the calibrate command.
- 9.2.4.4 Data handling.- Three analog channels are used for geophone outputs, two for GLA angle outputs, three for calibration, three for ASE temperature and power measurements, and the other four for ALSEP electrical power subsystem temperature and power measurements. The analog signals are multiplexed, converted to digital signals, and formatted for shifting to the central data subsystem and downlink transmission.

The ASE data format comprises thirty-two 20-bit words per frame with each word consisting of four 5-bit subwords. Geophones two and three are sampled and read out in every word of the frame. Geophone one is sampled and read out in all but the first word. In the first word geophone one is sampled and stored, then read out in the first subword of the second word of each frame. The first two subwords of word number one comprise a 10-bit frame synchronizing signal. The first three bits of subword one of word 31 provide a mode identification signal.

The binary signals from the multiplexer converter are applied to the shift register multiplexer gates which are controlled by the shift register multiplexing logic. A storage buffer is provided between the converter multiplexer and the shift register multiplexer gates. The ASE data is shifted out in the 32-word telemetry frame format to the biphasic modulator of the data subsystem for modulation and downlink transmission.

9.3 GRENADE OPERATION

After arming, a fire grenade real-time command (RTC) for one of the grenades is gated to the appropriate firing circuit causing the firing capacitor to discharge and ignite the grenade propellant via an Apollo standard initiator (ASI). As the grenade leaves the launch tube, a safe plate is spring ejected which permits a microswitch in the grenade to close, discharging a capacitor across a thermoelectric match which activates the thermal battery. The thermal battery, when activated, provides internal grenade power to drive the transmitter and to charge the detonator storage capacitor. The first of the two range-line breakwires is broken when the grenade is launched, initiating the range gate pulse to the real-time-event logic. Rocket propellant in the grenade

*
is exhausted before the grenade exits the tube. When the grenade is 25 feet into trajectory, the second range-line breakwire is broken terminating the range gate pulse to the real-time-event logic and providing time/distance data for subsequent determination of grenade velocity. The grenade transmitter, activated at launch and utilizing the grenade range line as an antenna, transmits until destroyed upon grenade impact. An omnidirectional impact switch in the grenade allows the detonator capacitor to discharge, firing a detonator to set off the grenade high explosive on grenade impact. The 30-MHz signal from the transmitter is received by the antenna mounted on the mortar box and conducted by coaxial cable to the receiver in the central station electronics. The received signal is applied through a level detector to the real-time-event logic for application to the data handling function. The grenade transmitter signal provides an indication of time of flight and instant of detonation providing an indication of range thus enhancing the confidence factor of the range calculations derived from the angle of launch and grenade velocity data generated from the inclinometer and the range-line breakwires.

NOTE

Due to the relationship between the receiving antenna and transmitting antenna (range line) radiation patterns, it may be possible to receive a loss of signal at or near the maximum height of the grenade trajectory. This loss of signal would generate a false impact RTE.

*

9.4 SAFETY FEATURES

9.4.1 ASE Central Electronics

Astronaut Switch 5, when in the clockwise position precludes inadvertent application of +29 Vdc operating power to the ASE, thus removing the capability to arm and/or fire the grenades or thumper.

9.4.2 Thumper

- A. An initiator selector switch which selects for firing only one initiator at a time while shorting the leads of all remaining initiators. This switch shorts all leads when in the "0" or off position.
- B. A definite two-step firing operation with a time delay is required to arm and fire an initiator. After the initiator selector switch is rotated from the "0" position to a numbered position, the thumper is armed by rotating the arm/fire knob 40 degrees and holding for a minimum of 4 seconds. The selected initiator is then fired by pressing the same knob, which discharges a capacitor through the initiator. If the firing sequence is stopped after the thumper is armed, the arm/fire control returns to its normal unactivated position and automatically discharges the arming capacitors in a matter of milliseconds. This control is also designed so that the firing switch is actuated only after the arming switch is activated.
- C. The ends of the initiator mounted in the thumper base which are exposed to the pressure and debris from adjacent initiator firings are covered with a coating of silicone rubber for protection against sympathetic firing of other initiators.

*

- D. Protection from direct exposure to the firing end of the ASI is afforded by the impact plate on the bottom of the thumper.
- E. Deflection of all exhaust gases downward. (Refer to Figure 9-2.)

9.4.3 Grenades

- A. Two safe/arm switches, located on the mortar box. One switch opens the arming circuit between the ASE central electronics and the mortar box and shorts out the rocket motor firing capacitors. The second switch provides a short circuit across the grenade rocket motor initiators.
- B. Grenade safety release assembly locks the grenades in the launch tubes to prevent unintentional launching. The safety release is removed by the astronaut prior to leaving the deployment area.
- C. A safe plate in each grenade provides a mechanical block between the detonator and the high explosive. The safe plate is held in place at all times when the grenade is in the launch tube and is spring ejected at launch. Thus, while the safe plate is in place, inadvertent detonator ignition will not set off the high-explosive charge. In addition, the safe plate maintains a microswitch in a position which prevents the actuation of the grenade thermal-battery output (refer to Para 9.4.3.D), and provides a low impedance path across the firing capacitors to prevent a static charge buildup.

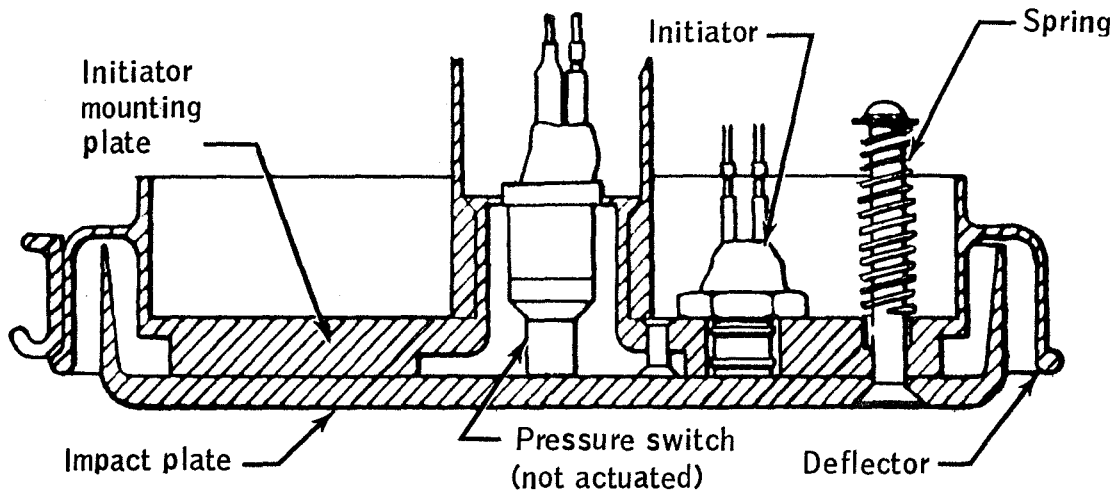

Thumper base section
non-operating

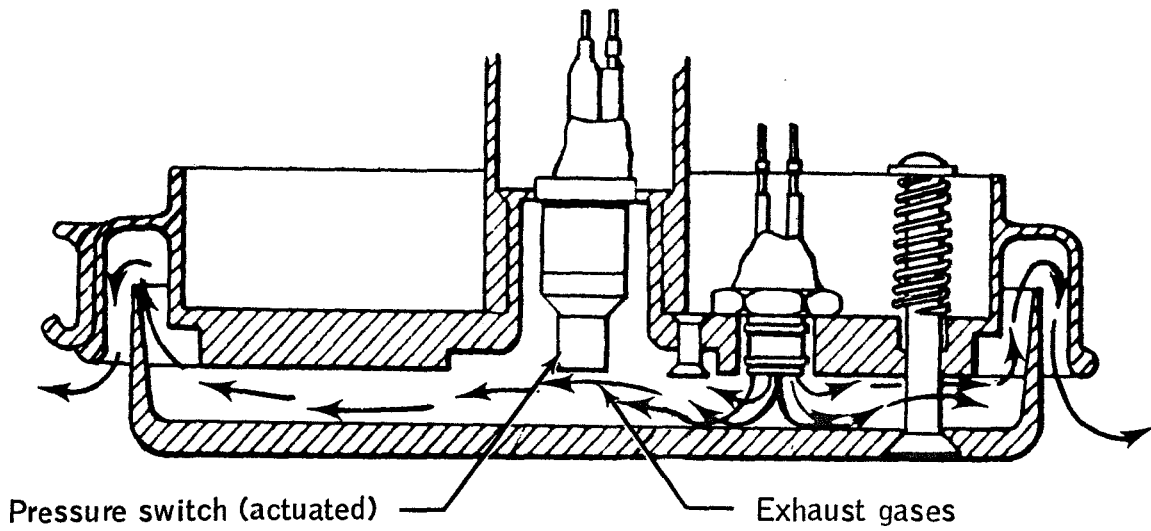

Thumper base section
operating

Figure 9-2. - ASE Thumper.

- *
- D. The grenade thermal batteries, the only source of energy for high-explosive detonation, are inactive and shorted while the grenades are in the launch tube. Safe-plate ejection at launch actuates a switch which removes the short and causes the discharge of a capacitor (charged via the arm command) through the thermal battery match thus activating the battery.
 - E. A time delay of approximately 8 seconds is required, after thermal battery activation, before the high-explosive initiator circuit is sufficiently charged.

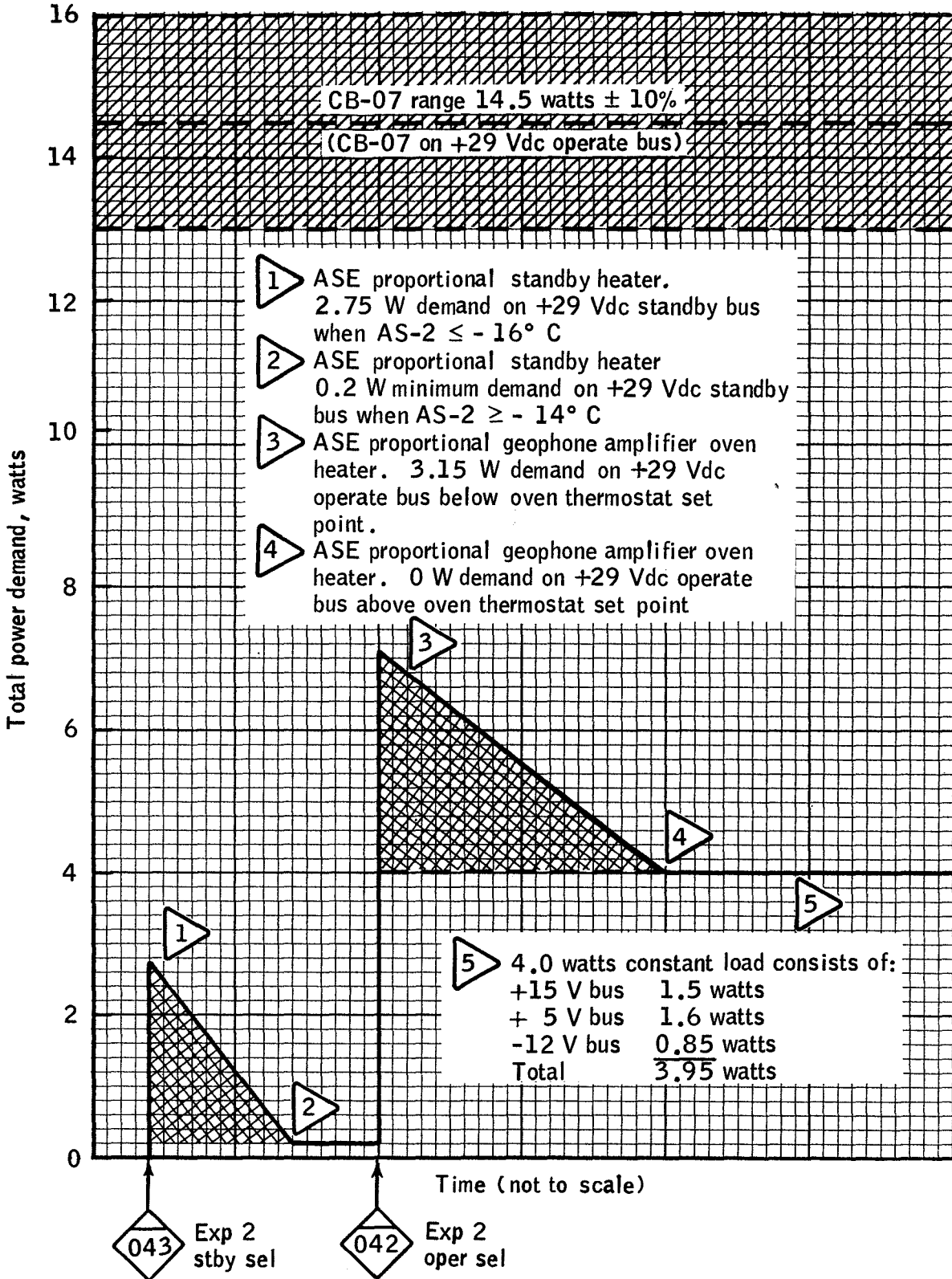

Figure 9-3. - ASE power profile.

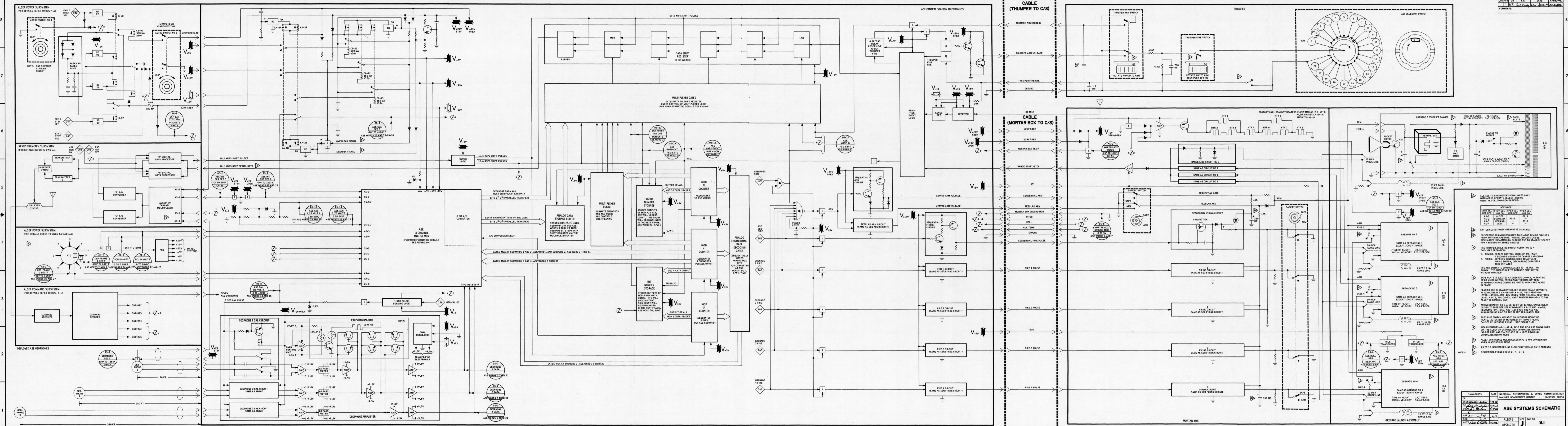

Table with columns: SIGNATURES, DATE, APPROVAL, COMMENTS. Includes a table for ASE MODE parameters (STBY SEL, STBY SEL, OPER SEL, OPER SEL, HIB OFF, HIB OFF, HIB OFF, HIB OFF) and a table for GRENADE parameters (GRENADE NO, TIME OF FLIGHT, INITIAL VELOCITY).

10 HFE (S037)

SECTION 10

HEAT FLOW EXPERIMENT (S037)

10.1 SYSTEM DESCRIPTION

10.1.1 Experiment Objectives

The heat flow experiment (HFE) measures the net outward flux of heat from the moon's interior. Measurement of lunar heat flux will provide:

- A. A comparison of the radioactive content of the moon's interior and the earth's mantle.
- B. A thermal history of the moon
- C. A lunar temperature-versus-depth profile
- D. The value of thermal parameters in the first three meters of the moon's crust.

When compared with seismic measurements, data from the HFE experiment will provide information on the composition and physical state of the moon's interior.

10.1.2 Major Components

The major components of the HFE are two sensor probes and an electronics package as shown in Figure 10-1.

10.1.2.1 Sensor probes.- The probes consist of epoxy-fiberglass tubular structures which support and house temperature sensors, heaters, and the associated electrical wiring. Each probe has two sections, each 55 cm (21.6 inches) long, spaced 2 cm (0.8 inches) apart and mechanically connected by a flexible spring. The flexible spring allows the probe assembly to be bent into a U-shape to facilitate packing, stowage, and carry.

There is a gradient heat sensor surrounded by a heater coil at each end of each probe section. Each of these two gradient sensors consists of two resistance elements. These four

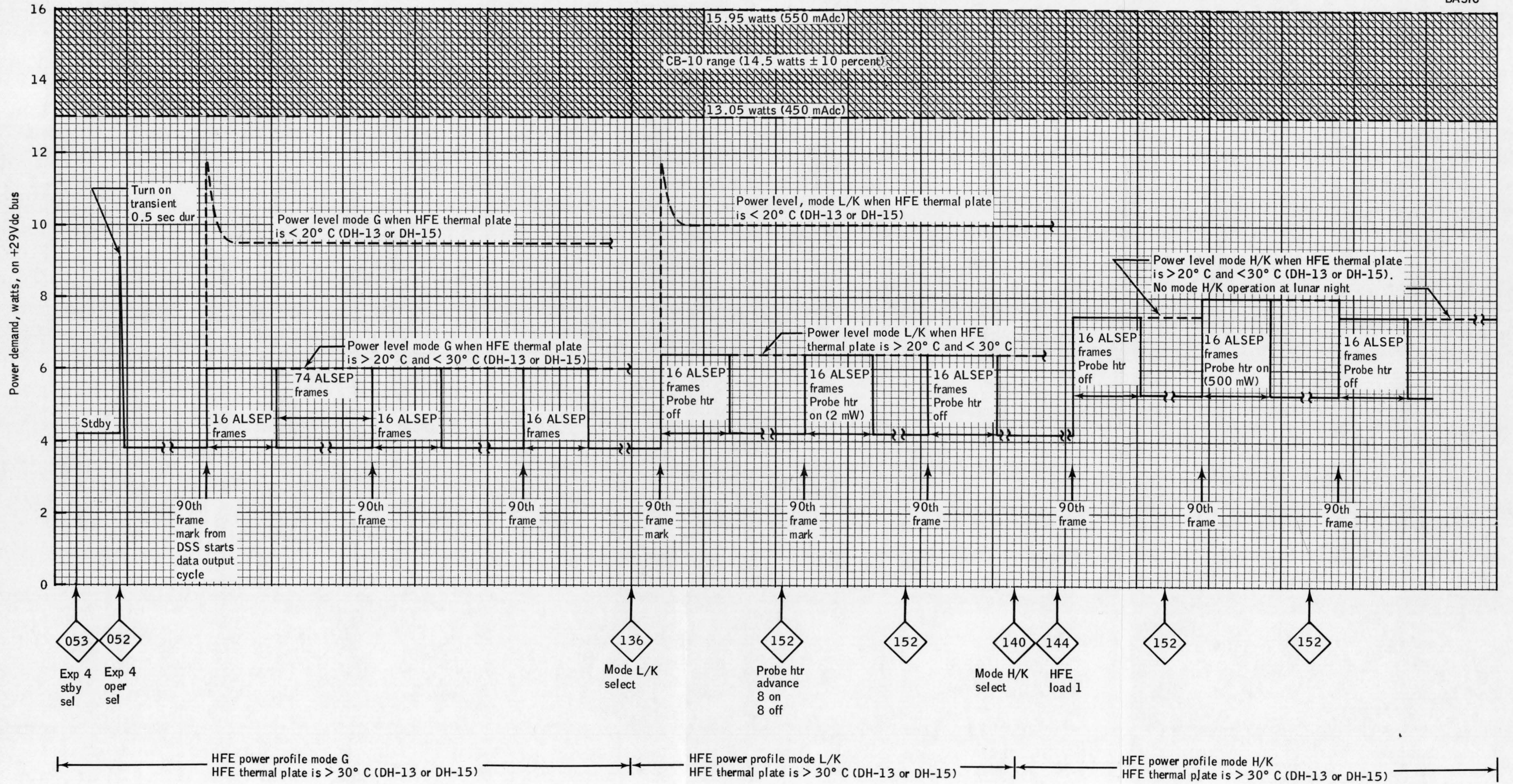

Figure 10-1. - HFE power profile.

resistance elements are connected in an electrical bridge circuit. Ring sensors are located 10 cm (4 inches) from each end of each probe section. Each of these two ring sensors has two resistance elements. These four resistance elements are connected into an electrical bridge circuit. Also, four thermocouples are located in the cable of each probe, identified and spaced as follows: number one at the upper end of the probe, numbers two, three, and four spaced 25, 45, and 65 inches up the cable from the end of the probe.

10.1.2.2 Electronics package.- The heat flow electronics package contains six printed circuit boards which mount the functional circuits of the experiment. An external cable reel houses the HFE/central station cable and facilitates deployment. A sunshield thermally protects the electronics package from externally generated heat. Two reflectors built into the open ends of this sunshield aid in the radiation of internally generated heat that otherwise might be entrapped under the sunshield. The electronics package is thermally protected by multilayer insulation and thermal control paint.

10.1.3 Deployment

The HFE is deployed with the two sensor probes emplaced in the lunar surface in 3-meter (10-foot) boreholes. These holes are drilled by the astronaut with the Apollo lunar surface drill (ALSD). The two probes are connected by two multiple-lead cables to the HFE electronics package which is deployed separately from the ALSEP central station.

10.2 HFE MODES

The HFE performs its measurements in three basic modes of operation: Mode 1 or Mode/G, Mode 2 or Mode/LK, and Mode 3 or Mode/HK.

10.2.1 Mode/G, Normal Gradient Mode

The normal gradient mode is used to monitor the heat flow in and out of the lunar surface crust. Heat from solar radiation flows into the moon during the lunar day and out of the moon during lunar night. This larger heat gradient in the near subsurface of the moon will be monitored and measured in order to differentiate it from the more steady but smaller heat flow outward from the interior of the moon.

10.2.2 Mode/LK, Low Conductivity, and Mode/HK, High Conductivity

Thermal conductivity of the lunar material is measured with the principle of creating a known quantity of heat at a known location by exciting one of the eight probe heaters, and measuring the resultant probe ambient temperature and temperature differentials for a period of time. Because it is not known whether the surrounding material will have a low conductivity (loosely consolidated material) or a high conductivity (solid rock), the capability to measure over a wide range using two modes of operation is incorporated into the HFE design.

10.2.3 Ambient Temperature Measurements

Ambient temperature measurements are made at any gradient bridge or at any one of the thermocouples spaced at four points along each probe cable. In each probe cable, the thermocouples are placed at the top gradient sensor and at distance increments of 25, 45, and 65 inches above the top gradient sensor. The reference junction for the thermocouples is mounted on the HFE electronics package thermal plate.

- *
10.2.3.1 Mode/G.- Normal (gradient) mode initiated by octal command 135 (gradient sensor excitation - no heater excitation). The heat gradients (temperature differentials) and probe ambient temperatures are measured with the gradient sensors and the thermocouples spaced along the two cables connecting the probes to the electronics Package. In each deployed probe, the temperature difference between the ends of each of the two sections is measured by the gradient bridge consisting of the gradient sensors positioned at the ends of the probe section. Gradient temperature differentials are measured in both the high sensitivity and low sensitivity ranges.
- 10.2.3.2 Mode/LK.- Low conductivity mode (ring source) initiated by octal command 136 (gradient sensor excitation - low heater excitation). The probe heater selected by octal command 152 receives low power excitation and dissipates 2 milliwatts of power. The thermal conductivity is determined by measuring the temperature rise of the gradient bridge around which the selected heater is located. The temperature which the heater must reach to dissipate the power input is the measure of thermal conductivity of the surrounding material. The low conductivity measurements are performed in the sequence selected by earth command.
- 10.2.3.3 Mode/HK.- High conductivity mode (heat pulse) initiated by octal command 140 (ring sensor excitation - high heater excitation). The probe heater selected by octal command 152 receives high power excitation and dissipates 500 milliwatts of power. The thermal conductivity is determined by measuring the temperature rise at the ring bridge nearest the selected heater. The temperature rise per unit of time at the known distance is the measure of thermal conductivity of the surrounding material. The high conductivity measurements are heat gradients in the high sensitivity range and probe ambient temperatures. The bridge used in performing a measurement is determined by the heater selected.

TABLE 10-I. - HFE MEASUREMENT OPTIONS (MODES 1 AND 2)

Location/Name	Cmnds and Order (Octal)	Symbol	135*	135*	135*	135*	135*	135*	135*	135*	135*	135*	135*	135*	135*
			141	141	141	141	141	142	142	142	142	142	143	143	143
			-	144	144	-	144	-	144	144	-	144	144	-	144
			-	-	145	145	-	-	-	145	145	-	-	-	145
			-	-	-	146	146	-	-	-	146	146	-	-	-
Temp grad high sens	DH-01														
Temp grad high sens	DH-02														
Temp grad high sens	DH-03														
Temp grad high sens	DH-04														
Temp grad low sens	DH-05														
Temp grad low sens	DH-06														
Temp grad low sens	DH-07														
Temp grad low sens	DH-08														
Probe ambient temp	DH-09														
Probe ambient temp	DH-10														
Probe ambient temp	DH-11														
Probe ambient temp	DH-12														
Temp ref junction	**DH-13														
Probe cable temp (1)	***DH-14,24,34,44														
Temp ref junction	**DH-15														
Probe cable temp (2)	***DH-16,26,36,46														

9-01

*** Thermocouple group measurement
 ** DH-13 and DH-15 are identical physical measurements separated in time by approximately 54 seconds
 * Command 135 selects Mode 1, Command 136 selects Mode 2

TC ₁ Group		R-Bits		TC ₂ Group	
Symbol	Data	R ₂	R ₁	Symbol	Data
DH-14	Ref TC-TC ₁ (4)	0	0	DH-16	Ref TC-TC ₂
DH-24	TC ₁ (4) - TC ₁ (1)	0	1	DH-26	TC ₂ - TC ₂ (1)
DH-34	TC ₁ (4) - TC ₁ (2)	1	0	DH-36	TC ₂ - TC ₂ (2)
DH-44	TC ₁ (4) - TC ₁ (3)	1	1	DH-46	TC ₂ - TC ₂ (3)

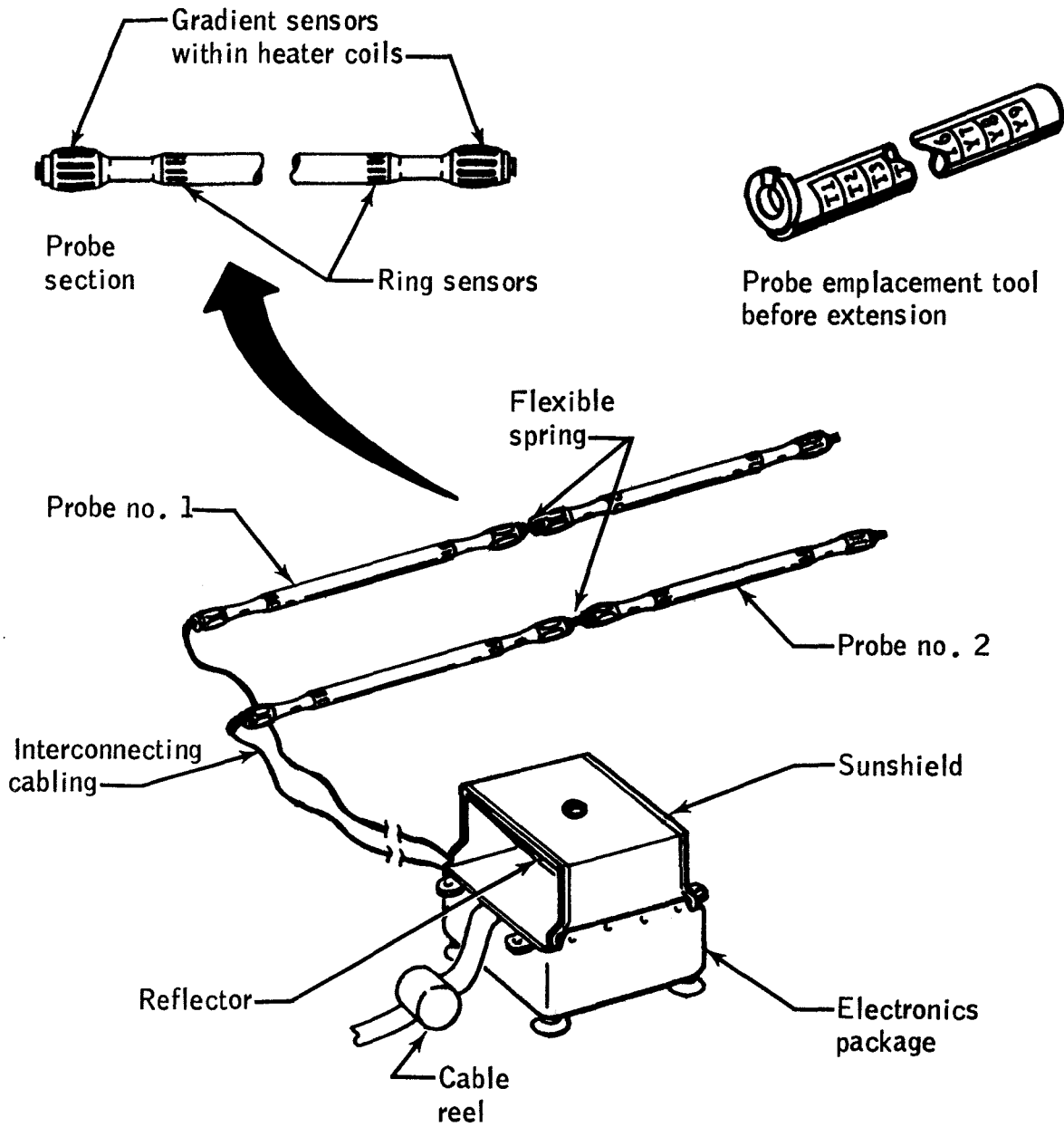

Figure 10-2. - Heat flow experiment.

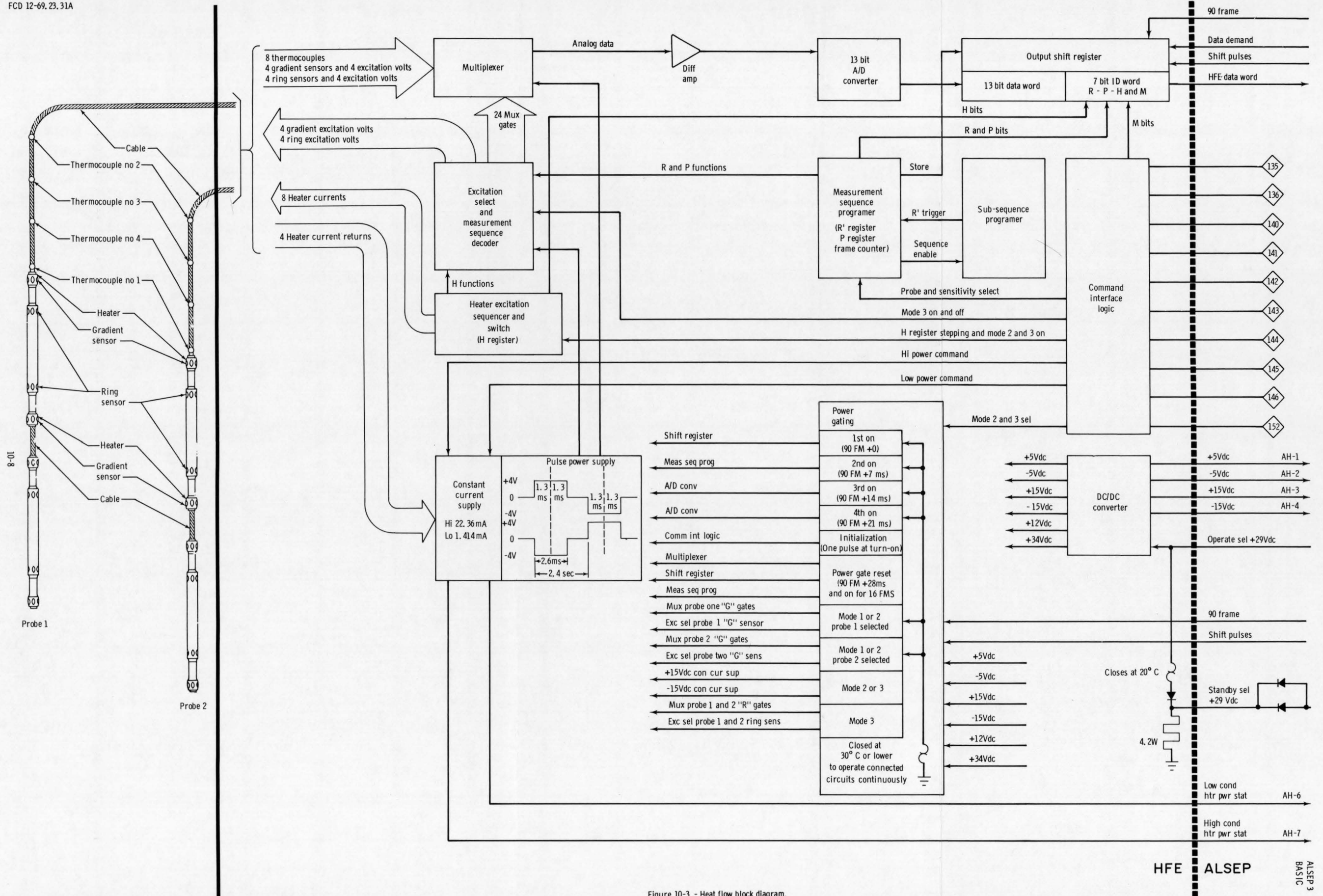

Figure 10-3. - Heat flow block diagram.

FCD 11-69.23.15A

Measurement sequences for one section of one probe ΔTH (modes 1 and 2)

1. Meas 1 + pulse P/S
2. Meas 2 + pulse P/S
3. Meas 1 - pulse P/S
4. Meas 2 - pulse P/S

ΔTL (modes 1 and 2)

1. Meas 3 + pulse P/S
2. Meas 2 + pulse P/S
3. Meas 3 - pulse P/S
4. Meas 2 - pulse P/S

Differential temp (mode 3)

1. Meas 4 + pulse P/S
2. Meas 5 + pulse P/S
3. Meas 4 - pulse P/S
4. Meas 5 - pulse P/S

Ambient temp (mode 3)

1. Meas 4 + pulse P/S
2. Meas 6 + pulse P/S
3. Meas 4 - pulse P/S
4. Meas 6 - pulse P/S

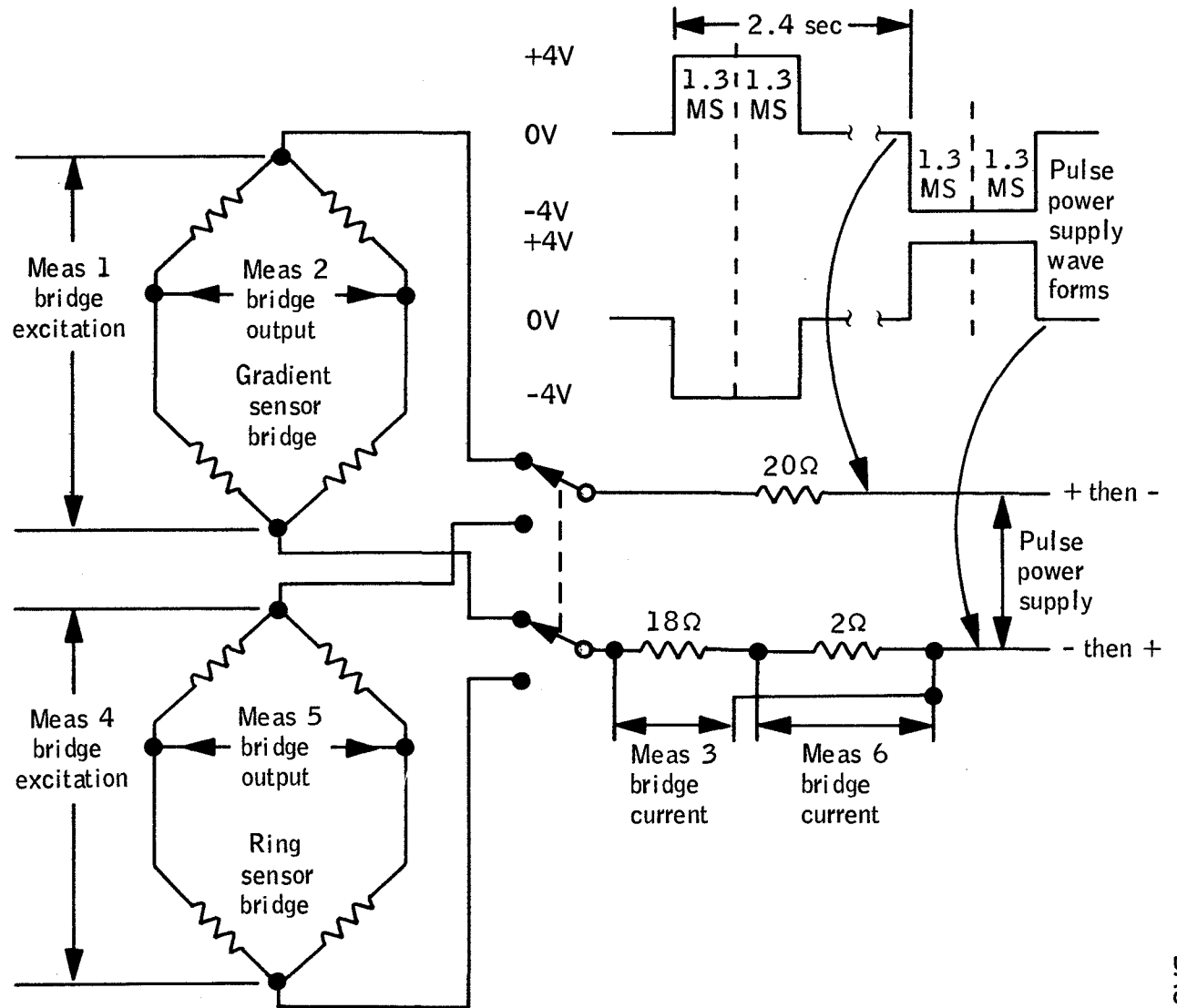

10-9

Figure 10-4. - Heat flow probe measurement sequences.

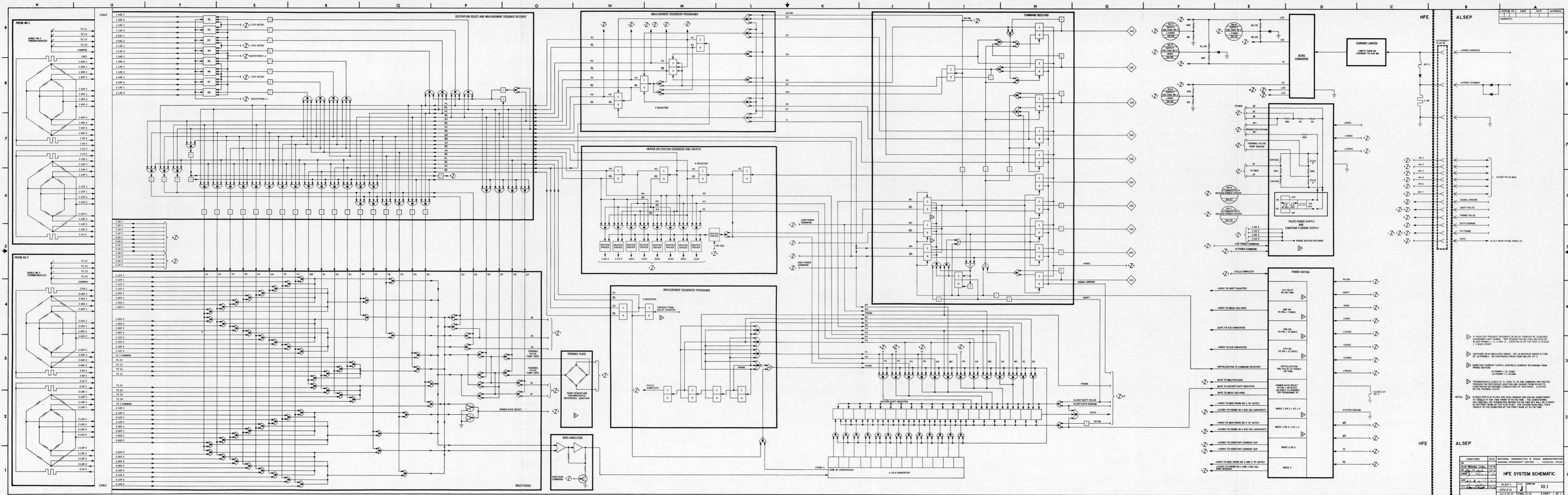

DATE	BY	CHKD	APP'D	DATE	BY	CHKD	APP'D
10/11/68	W. J. ...						
10/15/68	W. J. ...						
10/16/68	W. J. ...						
10/17/68	W. J. ...						

10.1	10.1	10.1	10.1
10.1	10.1	10.1	10.1
10.1	10.1	10.1	10.1
10.1	10.1	10.1	10.1

* REGISTER TRIGGERS ORIGINATE IN DELAY COUNTER OF SEQUENCE PROGRAMMER (NOT SHOWN). TWO TRIGGER PULSES FOLLOW EACH OF ALSEP FRAMES 1, 4, 8 AND 12. EACH PULSE OF THE PAIR IS SPACED 1.5 MSEC APART.
 * SWITCHED ON IN INDICATED ORDER. OFF IN REVERSE ORDER AT END OF 16 FRAMES. ON CONTINUOUS WHEN TEMP BELOW 30° C.
 * CONSTANT CURRENT SUPPLY CONTROLS CURRENT RETURNING FROM PROBE HEATERS.
 * POWER = 22.30mA
 * LOW POWER = 2.141mA
 * THERMOCOUPLE LEADS TC 11 THRU TC 24 AND COMMONS ARE ROUTED THROUGH THE REFERENCE JUNCTION AND CHANGE FROM ADJACENT CONSTANTAN OR CHROMEL CONDUCTORS AT THIS POINT, LOCATED ON THE THERMAL PLATE.
 * REGISTER FLIP-FLOPS ARE DUAL RANKED AND CAN BE CONTINGUOUSLY TOGGLE AT ANY TIME PRIOR TO 90 FM TIME. THE CONTINGUOUS TOGGLE WILL BE TERMINATED BEFORE 90 FM TIME BUT WILL BE STORED IN THE FIRST BANK OF THE FLIP-FLOP. THE SECOND BANK WILL THEN TOGGLE TO THE CONTENTS OF THE FIRST BANK AT 90 FM TIME.



APOLLO

ALSEPSH

**APOLLO LUNAR
SURFACE
EXPERIMENTS
PACKAGE
SYSTEMS
HANDBOOK
APOLLO 16**

**ALSEP 3
ARRAY D**

JANUARY 12, 1972



**FCD
MSC
NASA**